

# TABLE OF CONTENTS

TABLE OF CONTENTS.....	1
NEW FEATURES OF NANOCAD 23.0.....	5
NEW FUNCTIONALITY OF NANOCAD 23.0.....	5
Batch File Processing.....	5
Batch Purge of xref Files.....	8
New Visual Styles.....	9
Visual Styles Manager.....	11
Materials.....	12
Materials Library.....	13
Assigning Materials to Object Faces.....	13
Views Development.....	14
Auditing Viewports.....	16
Viewport Alignment.....	16
Arc Text Command.....	16
Rectangle from Center Command.....	19
Layer Options in the Drawing Explorer.....	19
Multiline Text Editing Restart Mode.....	20
Text Character Spacing.....	20
Dimensions.....	21
Copying Hatch Background.....	22
Aligning Raster Image.....	22
Import of Page Setups in the Batch Print Dialog.....	22
Sorting in the Batch Plot Window.....	23
Disabling Layer Information when Printing to PDF.....	24
Removing Duplicate Objects when Importing PDF.....	24
Bounding Prism by Selection.....	25
UCS by 3D Object Face.....	26
DUCS when Specifying a Vertex.....	27
Rotating the model with the Mouse Wheel.....	28
IFC Import.....	29
Lengthening Smooth Polylines.....	30
Selecting and editing polyline segments.....	30
3D Knot and Vertex Snaps to Spline.....	31
Create a Document from the Command Line.....	32
Non-Dialog Version of the -ATTEXT Command.....	32

Copying Properties.....	32
Select Group Command Button .....	32
Selection Dialog Button .....	33
Switching the ribbon content .....	33
Improved Search in the Interface Settings Window .....	34
Inserting an Underlay by Control Points.....	34
Multiple xrefs Insertion .....	35
Highlighting External References in a Drawing.....	36
New Commands in the External References Dialog Box .....	38
<b>FIXED BUGS.....</b>	<b>38</b>
Corrections in the Work of Multiline Texts .....	38
Corrections in Work with Text and Attributes .....	39
Corrections in Work with PDF Files.....	39
Corrections in Graphics Display .....	40
Fixing the Work of Snaps .....	40
Fixes and Improvements when Drawing.....	40
Corrections in Work with Non-DWG Files and from Other CAD Programs.....	41
Plot Corrections and Work with Layouts.....	41
Fixing IFC Import .....	45
Work with Layers .....	45
Fixing Bugs that Caused the Program Closedown.....	46
Crashes and Errors on Certain Files.....	47
Other Corrections.....	47
<b>POINT CLOUDS.....</b>	<b>56</b>
Work with Databases .....	56
Managing the Display of Features in a Cloud .....	57
Getting Pipe Parameters .....	58
Import of Point Clouds .....	58
Differentiating Clip Commands.....	60
Snap to Pipeline Turning Point.....	61
<b>TOPOPLAN MODULE. NEW COMMANDS.....</b>	<b>61</b>
New Topoplan.....	61
Recalculation of Coordinates.....	61
Mesh Simplification.....	62
3D Slope.....	62
3D Polyline Offset.....	63
Surface Difference.....	63

Coloring Elevation Legend .....	64
Topographic Hatches.....	65
Creating Geopoints Manually .....	65
Creating a Group of Geopoints Manually.....	66
Creating Groups of Geopoints by Original Description .....	66
Editing, Renaming and Deleting a Group .....	67
New Grips of Geopoints .....	67
Creating Geopoints by Points and Texts.....	68
Export Geopoints .....	68
Points Conversion .....	69
Creating Label and Marker Styles of Geopoints.....	70
Editing Marker Style and Label Style Properties.....	71
User-Defined Properties of Geopoints .....	72
Batch Upload of Georeferenced Rasters .....	75
Search for Key Lines on the Surface .....	75
TOPOPLAN MODULE. UPDATED FUNCTIONALITY .....	75
Deleting an Edge .....	75
Painting Mesh by Elevation .....	76
Import Geopoints.....	77
Improved Import of Geopoints.....	78
Creating User-Defined Properties of Geopoints .....	78
Improved Data Typing .....	79
Other Improvements of Geopoints Import.....	80
KML/KMZ Import .....	82
Import of KML/KMZ files .....	82
Changing the Scale of Geopoints and Conventional Signs .....	83
Creating TIN by Points.....	83
Changing the Anchor Point when Inserting Layout Frames .....	84
Precise Shape of Layout Frames .....	85
Other Developments and Improvements.....	87
3D MODULE .....	88
3D History.....	88
Presspull .....	89
Extrusion.....	90
Face Alignment .....	91
Stretching by Sections .....	91
Parameters Manager.....	92

NEW IN 3D MODULE .....	92
Corrections .....	95
CONSTRUCTION MODULE .....	96
BCF .....	96
Library.....	96
Corrections .....	96
MECHANICA MODULE .....	97
Assembly Units.....	97
Changing 3D Type of an Assembly Unit.....	97
Document Properties Window .....	98
Assembly Unit Properties Window .....	99
Specification by 3D Model.....	99
Specification Positions.....	101
Stamping.....	102
Flanging .....	103

# NEW FEATURES OF NANOCAD 23.0

## NEW FUNCTIONALITY OF NANOCAD 23.0

### Batch File Processing

The utility for batch purging and initial fixing of problem files has been implemented. It allows you to correct errors (AUDIT command) and clean up unnecessary data (-PURGE command) in several user-specified drawings at once. In the dialog, you can specify the required cleaning options and other program settings. The utility also allows you to supplement the processing script with drawing correction commands that will be executed in the order specified by the user.

The batch purge dialog box opens by the **Batch File Processing** (BATCHPROCESS) command.

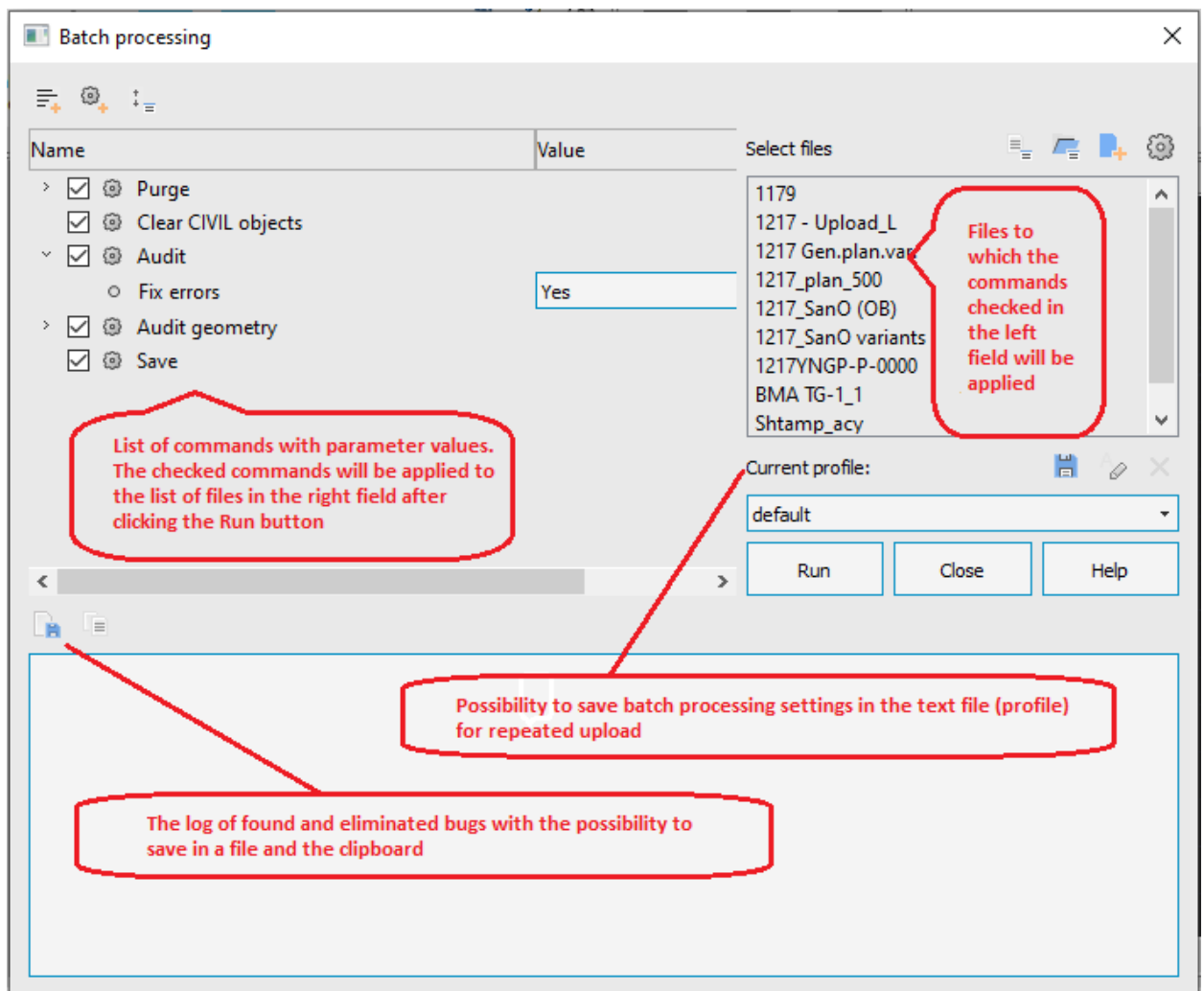

The list of files selected for processing is displayed on the right. You can add files one by one or as a whole folder. On the left there is a list of commands available for execution with a list of their parameters. The checked boxes indicate the commands and actions to be performed for each file.

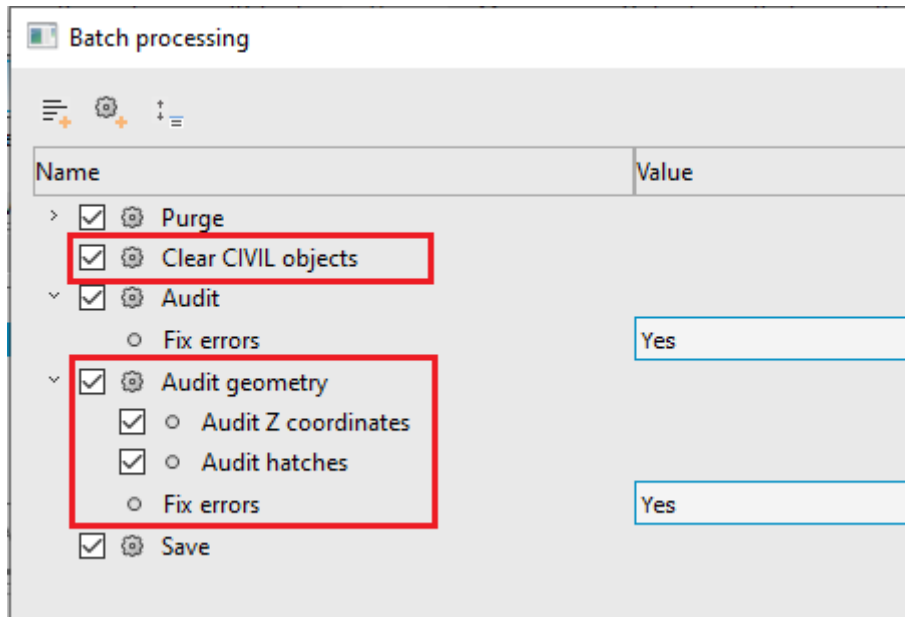

Purge is also performed on disabled, frozen and blocked layers.

It is possible to purge all categories provided in the non-dialog version of the -PURGE command, including: empty entries in the sort table, annotative scales, registered applications.

Batch processing settings can be saved to a new settings profile for their further use.

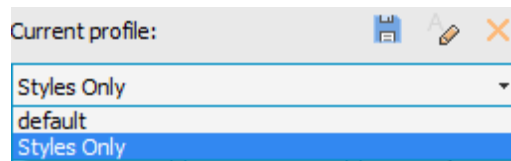

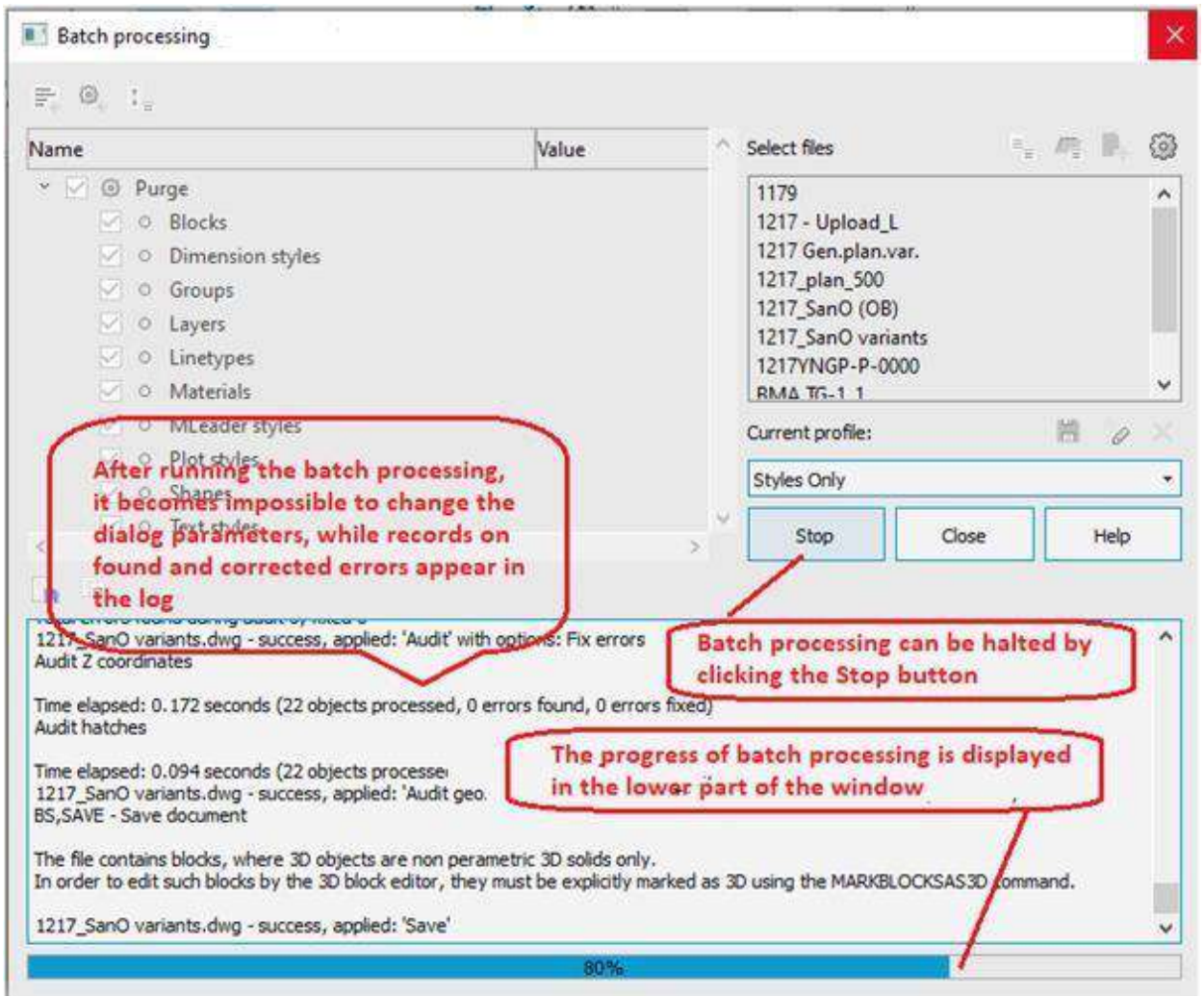

After the check is completed, the final report can be copied to the clipboard or saved to a separate file.

The **Reorder commands**  button has been added to allow you to change the commands order using drag&drop.

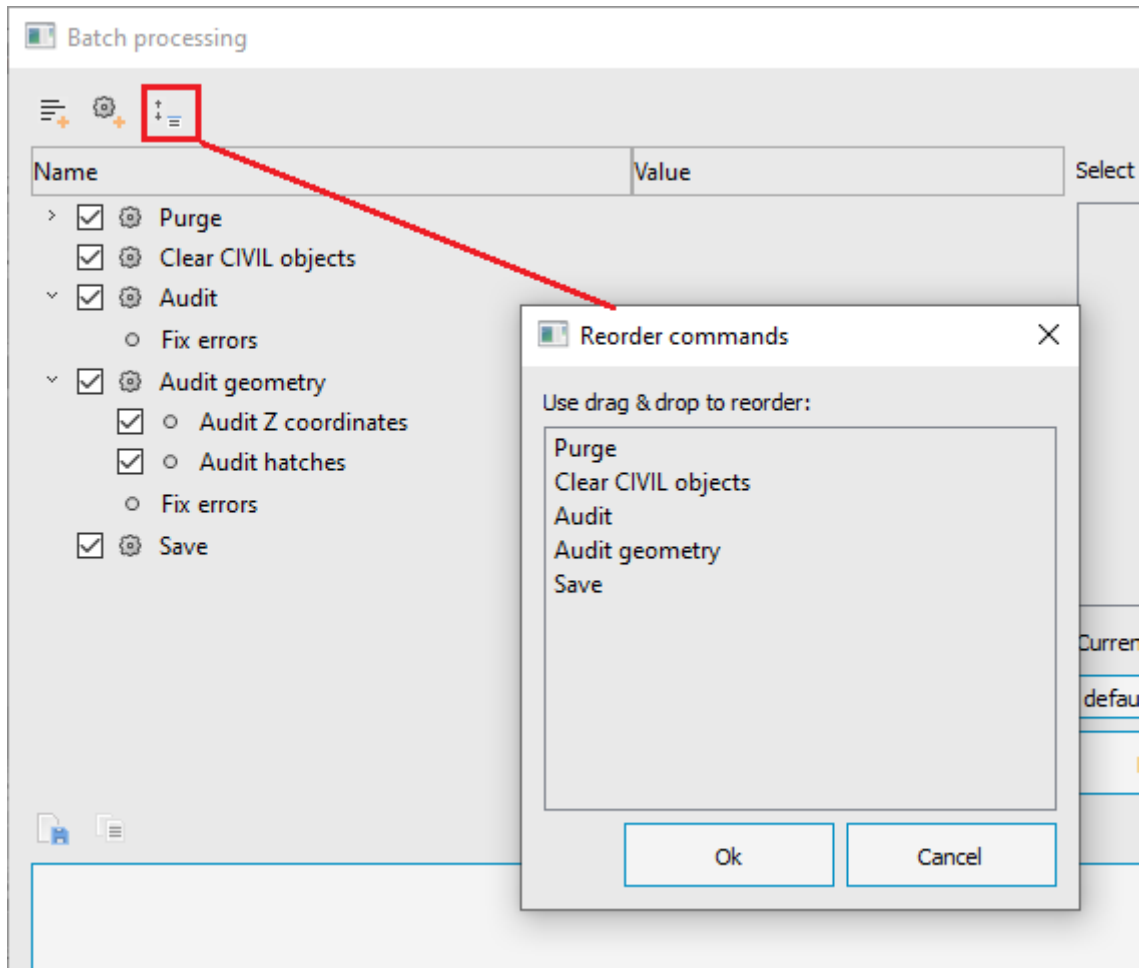

There is also a settings button for selected folders, where you can specify whether files in subfolders should be processed.

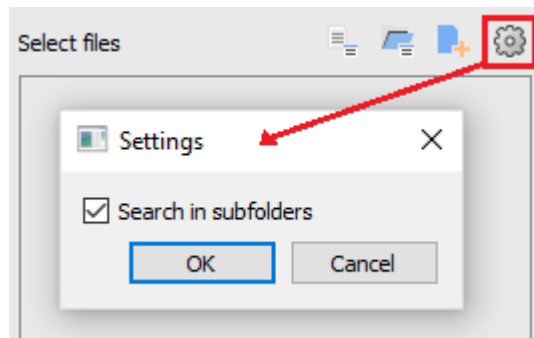

### Batch Purge of xref Files

In addition to the standard features of the -PURGE command, batch processing provides the possibility to purge external reference files (the **Purge xrefs** checkbox).



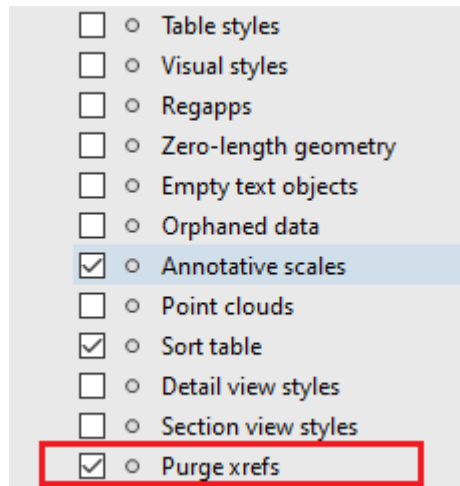

For example, if there are problematic files with annotative scales, you need to purge all external references at once to get rid of these scales.

Batch Processing automatically opens xref files and purges them. And then updates all external references.

## New Visual Styles

In 23 version of nanoCAD, new visual styles have become available with the possibility to edit their parameters and create new ones.

New visual styles:

- **Conceptual** – objects are displayed using smooth shading and Gooch face style. Gooch face style is characterized by transitions between cold and warm, rather than between dark and light shades of colors. This effect is less realistic, but it better represents the model details.
- **Realistic** – objects are displayed using smooth shading and showing materials.
- **Wireframe** – objects are displayed using lines and curves only. Draw order and fill options from 2D solids are not displayed. This visual style does not result in repeated creation of the view when the view direction is changed, as is the case with the **2D-Wireframe** visual style. In large 3D models, the time savings will be significant.
- **Hidden** – objects are displayed as wireframe; lines related to back faces are not displayed.
- **Shades of Gray** – objects are displayed using shades of a single color (gray) with smooth transitions.

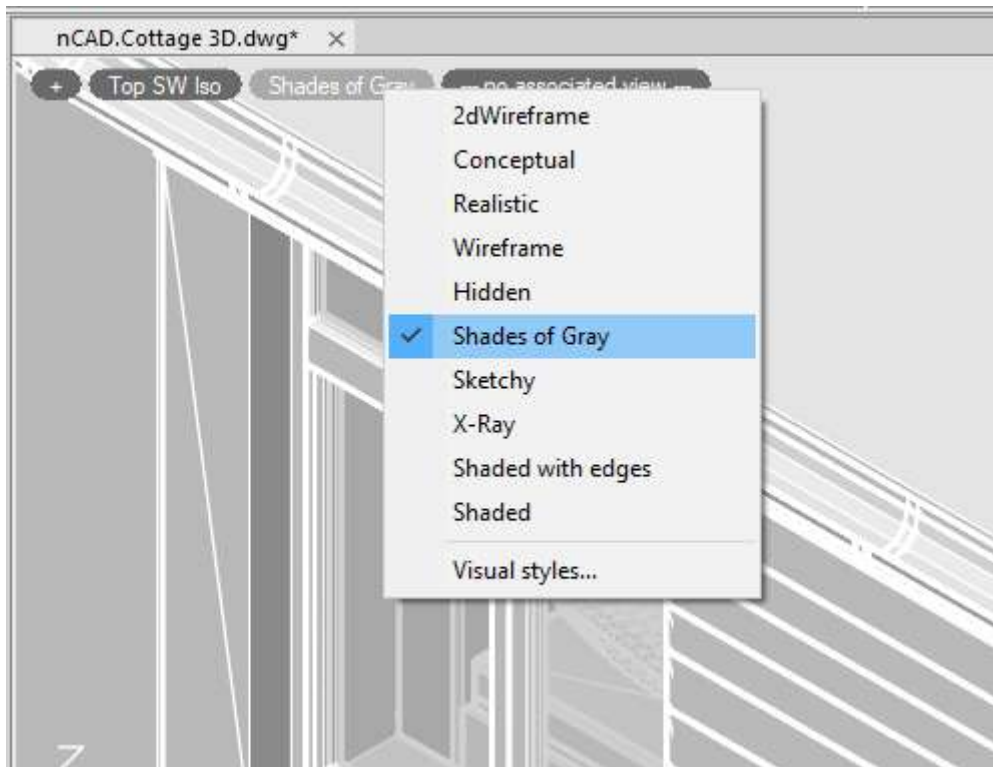

- **Sketchy** – objects are displayed with a freehand drawing effect, taking into account the Line Extend and Jitter edge modifiers.
- **X-Ray** – objects are displayed partially transparent.

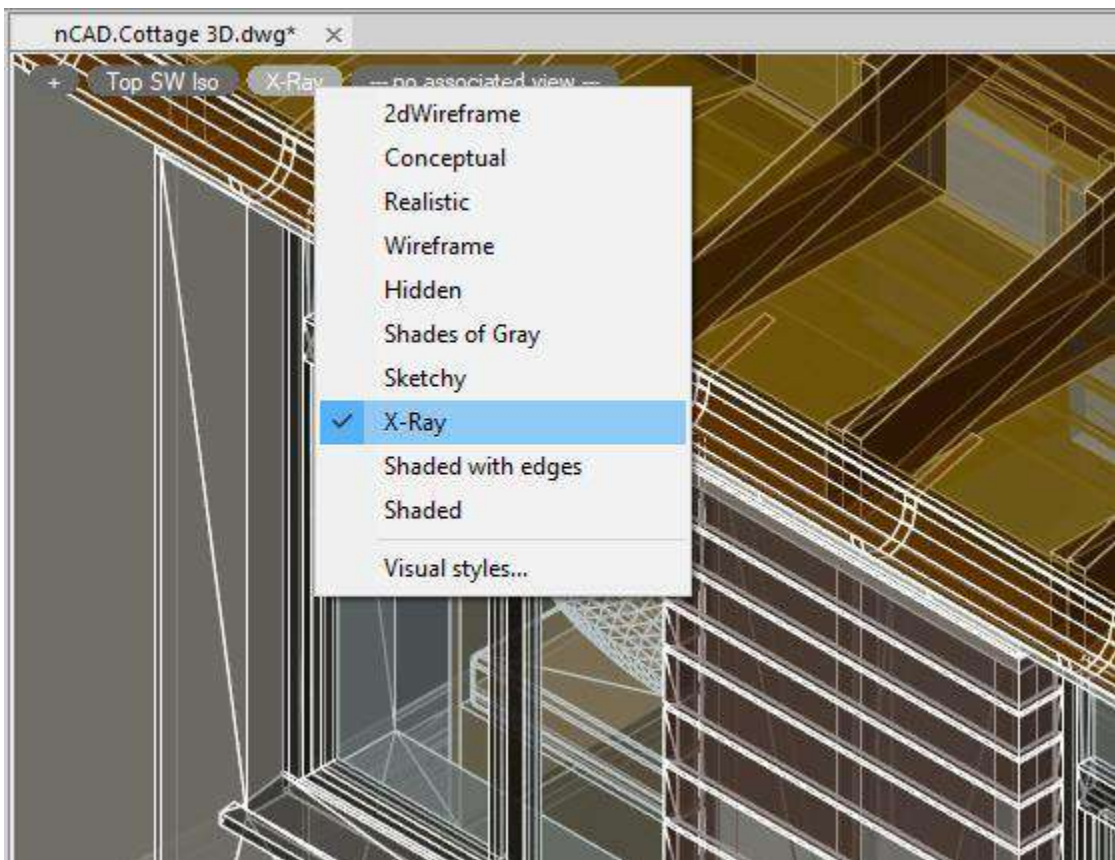

- **Shaded with edges** – objects are displayed using smooth shading with visible edges.
- **Shaded** – objects are displayed using smooth shading.

## Visual Styles Manager

You can create a new visual style or edit the existing one in the **Visual Styles Manager** (VISUALSTYLES

command  )

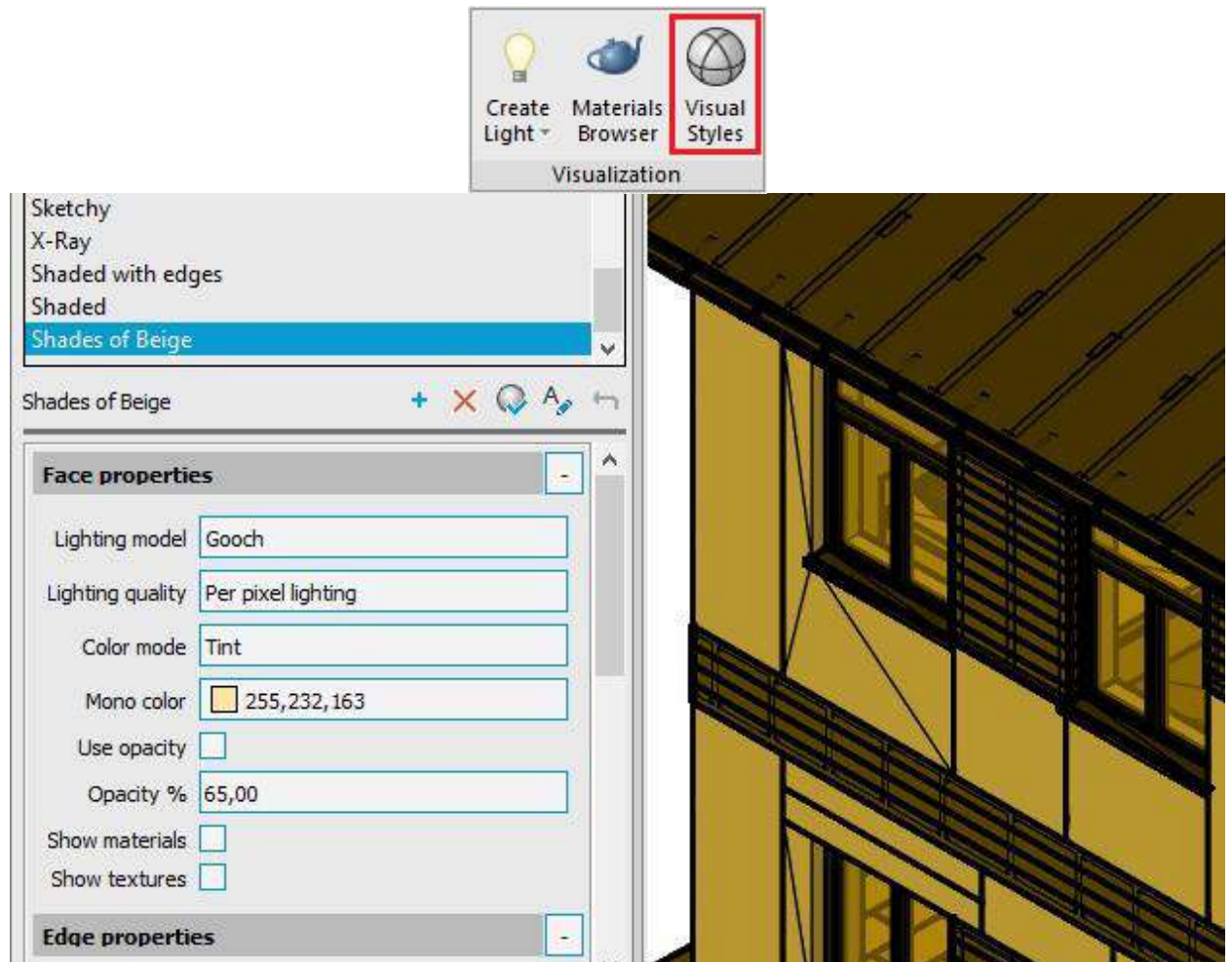

Using the context menu, you can quickly apply any style to the current viewport, after which it becomes possible to observe the effect of changing the style settings in real time.

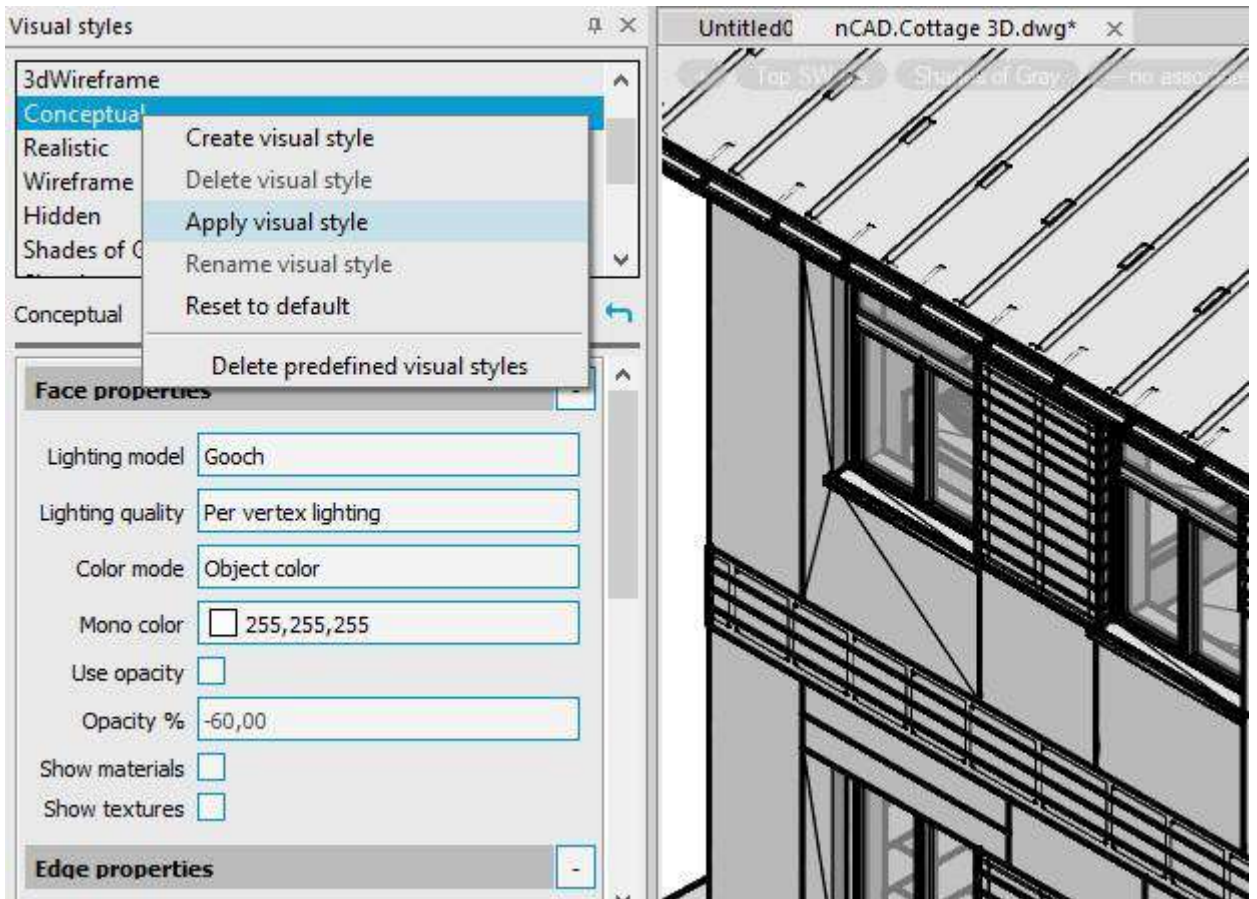

## Materials

The **Materials Browser** and **Material Editor** are opened with the MATBROWSEROPEN command.

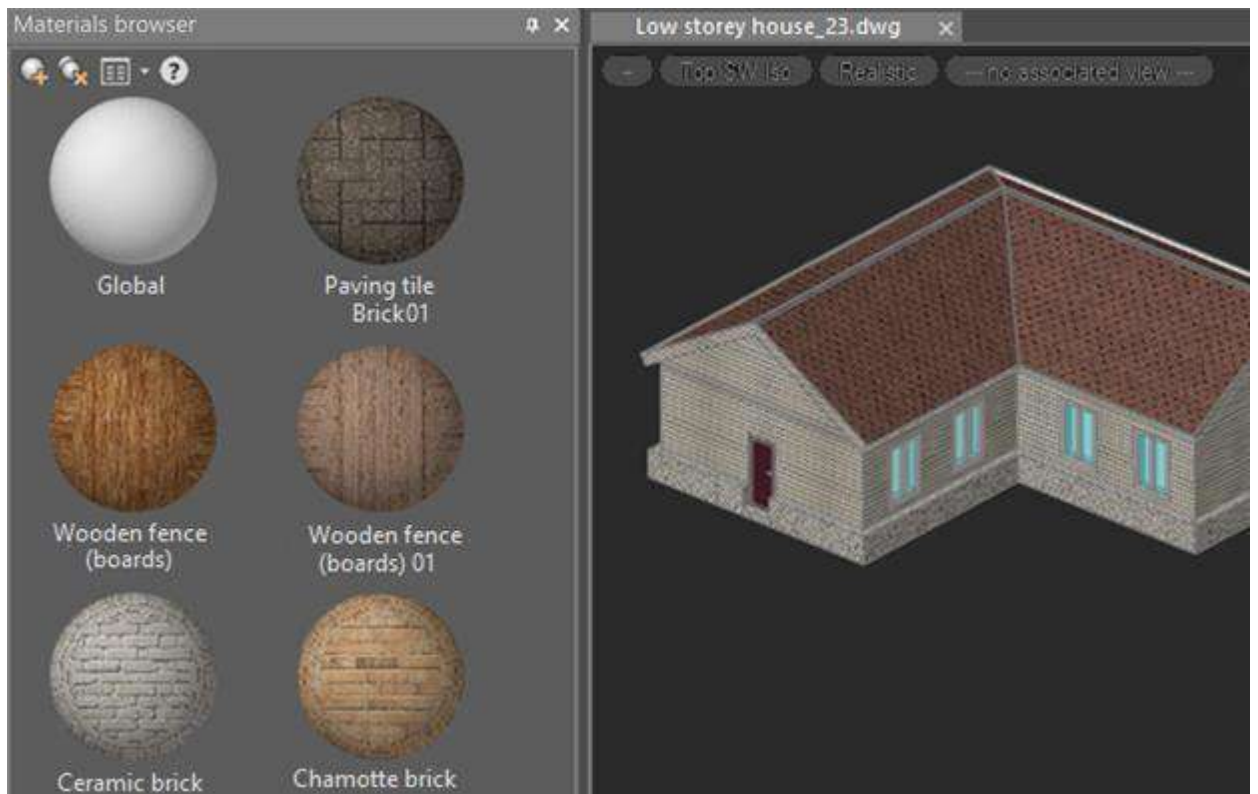

## Materials Library

The Materials Library has been added to the distribution kit. By default, it is located in `c:\Users\<UserName>\AppData\Roaming\Nanosoft AS\nanoCAD x64 23.0\CoveringsLibrary\`. You can change its location in the **Standard directories** section of the **Options** dialog. There is also an option to add custom materials libraries:

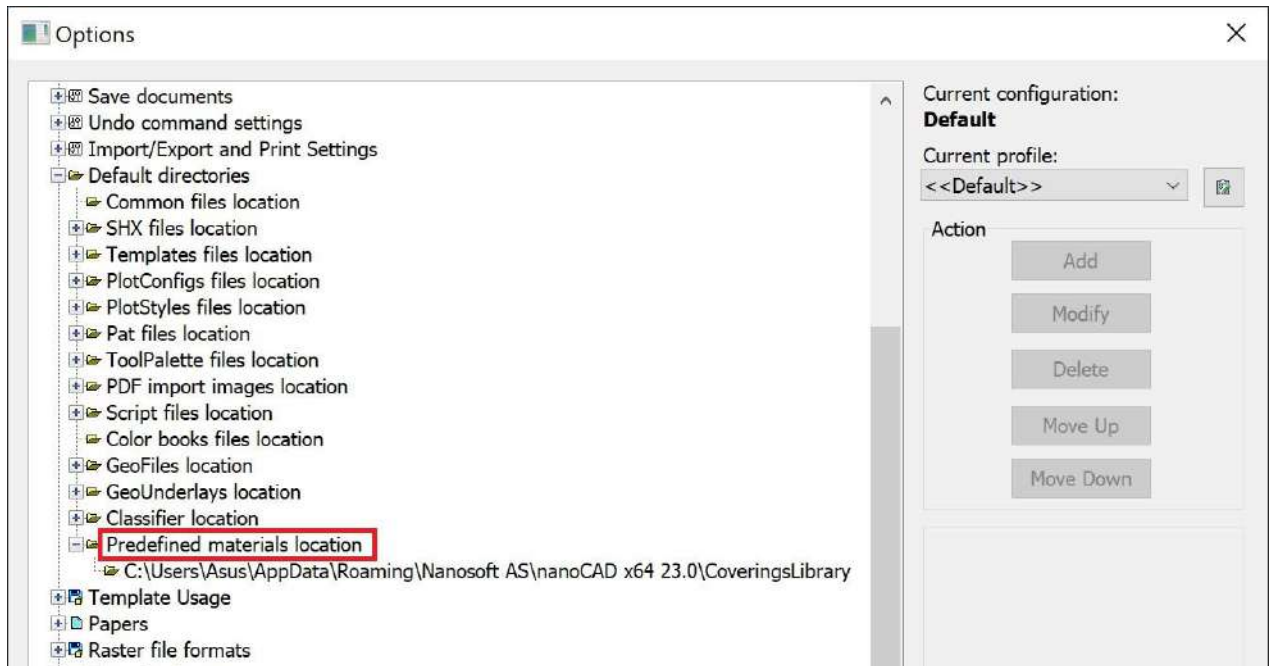

The Materials Library is available as a new section in the **File Explorer** (ADCENTER). There you can view the materials of the library and add them to the current document using the context menu command.

## Assigning Materials to Object Faces

It has become possible to assign a personal materials to any individually selected faces of one or more objects. Thus, for each face of the object, its own materials can be assigned. Individual faces of objects can be selected while holding down the CTRL key. In previous versions of the program, it was possible to apply texture only for the entire object.

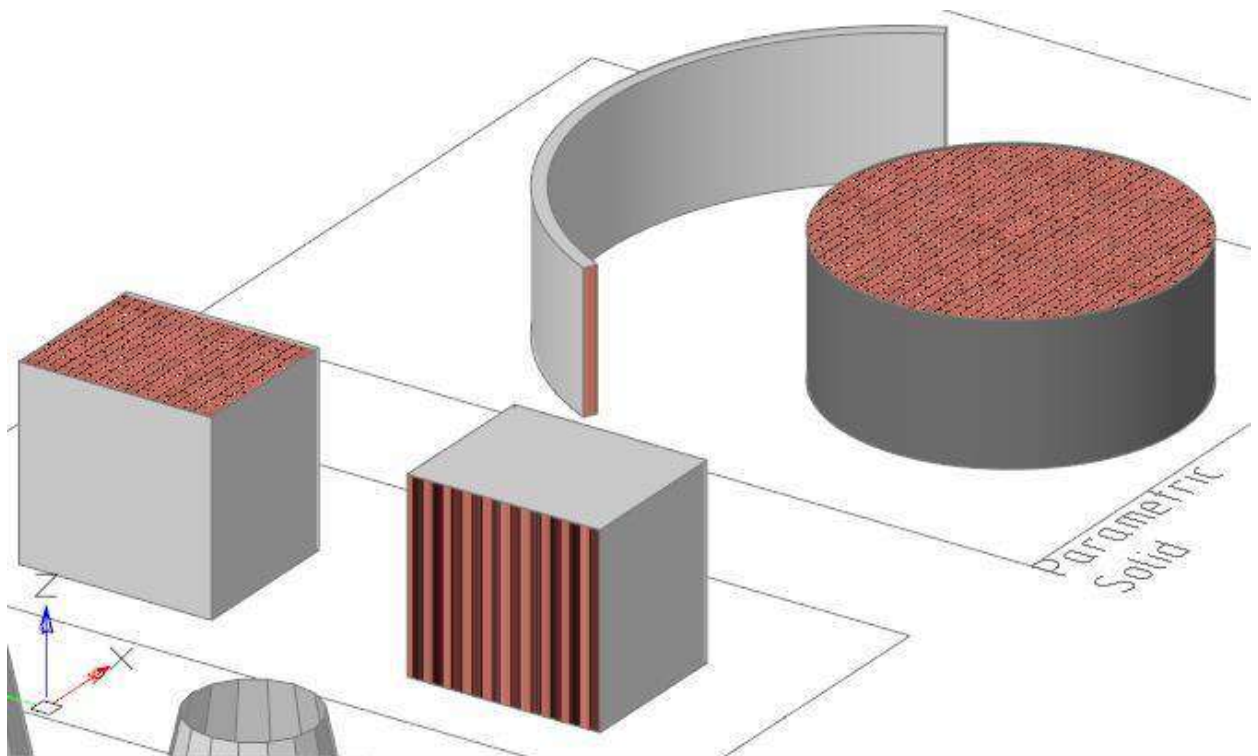
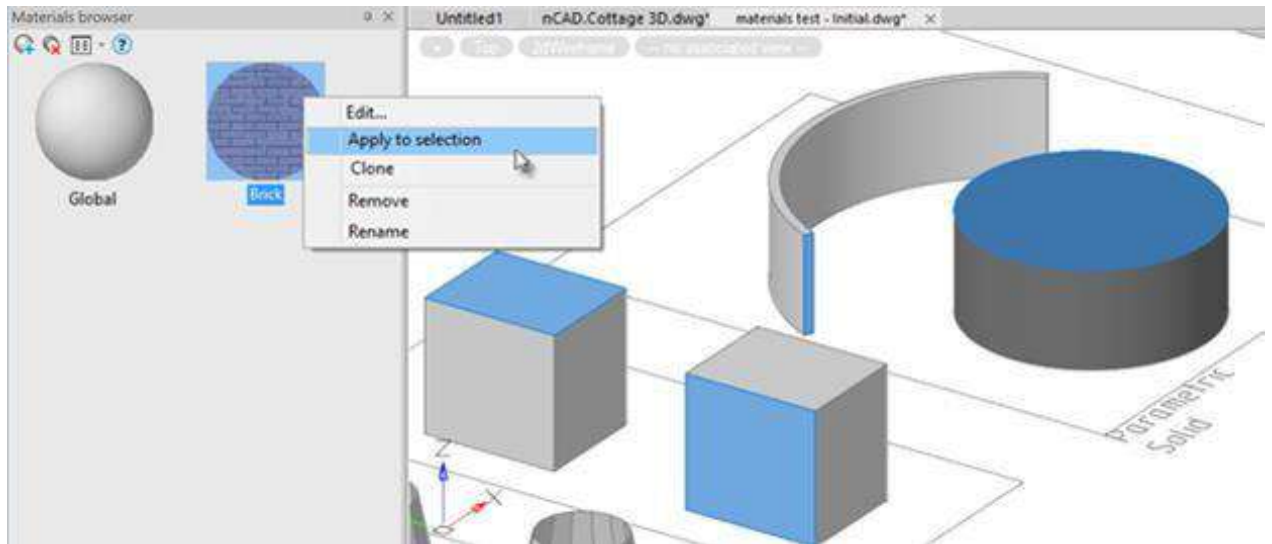

## Views Development

The new version has significantly redesigned the mechanics of creating and managing named views, which now remember not only the camera position, but also the visual style (new functionality), visibility/freeze state of layers, parameters of the bounding prism, position of the user coordinate system, and other parameters.

The principal innovation is the ability to manage subsets of objects that are displayed in a particular view. When creating a view, you can form a set of objects and thus create a “white list” that will be assigned to this view. In addition to this, through the software interface, you can also realize the reverse display logic based on the “black list”.

New API options for work with views allow you to create different styles of views for variable display of objects in vertical applications. Styling views makes it possible for any type of object to assign a separate display method depending on the view context (plan, section, section, diagram, etc.). With the help of styles, you can also override the basic properties – color, line type and thickness, hatch type and color, set the texture, etc. Using predefined view styles allows developers of vertical applications to achieve a high degree of automation in creating working documentation in compliance with all regulatory requirements.

In fact, new generation views are implemented in nanoCAD 23.

Like ordinary named views, they can be saved under a separate name through the VIEW command option, but a special Model space widget has been developed for quick switching:

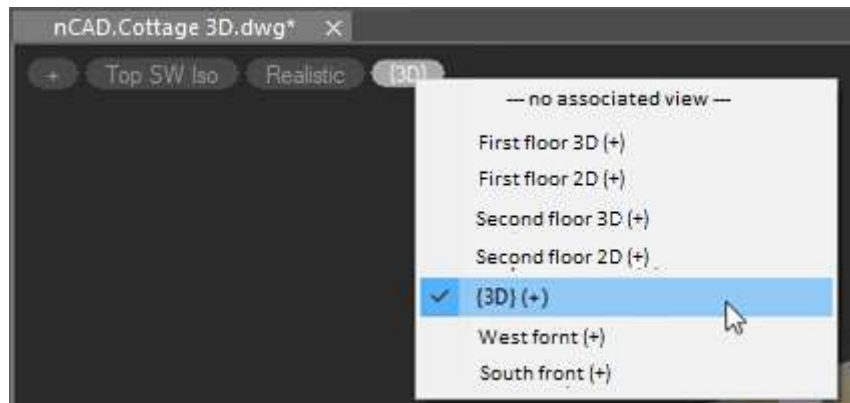

In addition, views can be assigned to viewports both in the Model space (split the work window into work frames) and in the Paper space. At that, any of these views is just a display of one model – changing an object geometry entails changing all the viewports on which this object is displayed, including providing a dynamic two-way link between the model and the drawing.



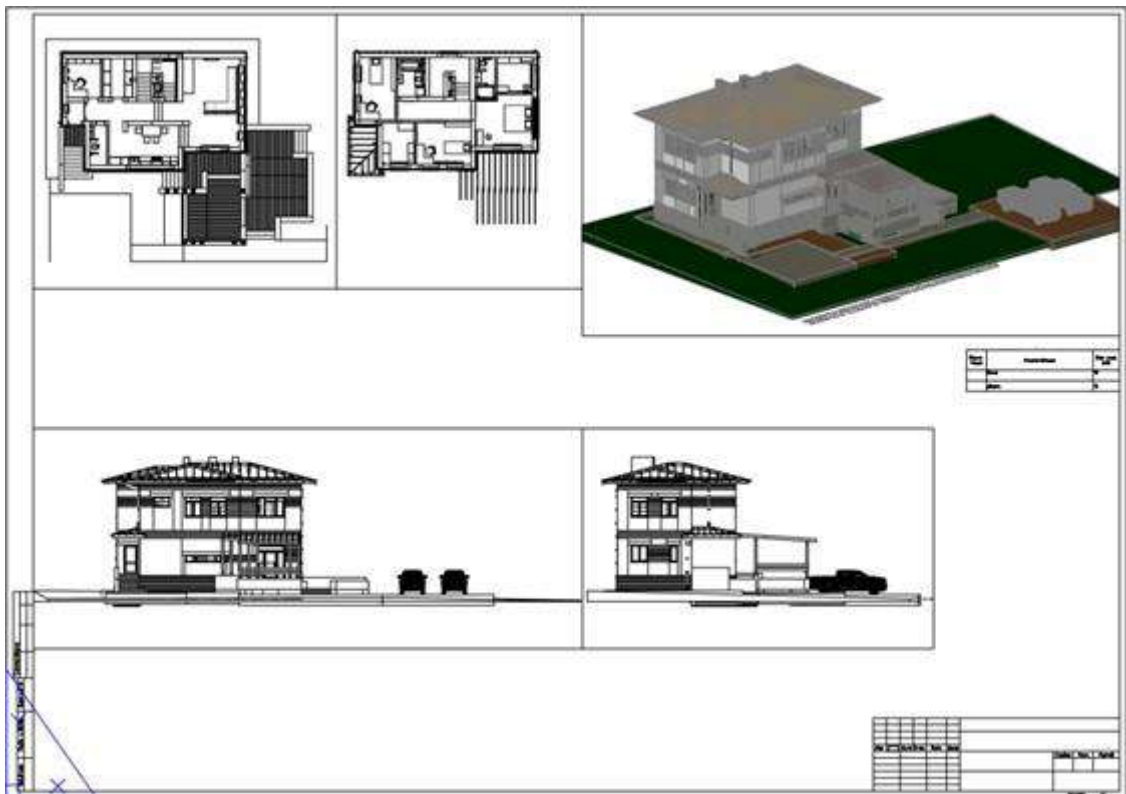

## Auditing Viewports

When opening files, viewport data integrity audit has been added. When data integrity violation is detected, a dialog box is displayed prompting you to automatically fix errors:

The audit is performed:

- if the document contains many “hanging” objects that should be in the paper space block, but are not in it. After correction, the objects are added to the block.
- if in the layout a display boundary is set to the general viewport of the layout. After correction, the display boundary is removed from this viewport.
- if one polyline was selected as the display boundary for several viewports. After correction, display boundaries are removed from such viewports, the polyline remains.
- audit for storage of incorrect lists of viewports in the layout. After correction, the viewport lists are re-read from the paper space block.

## Viewport Alignment

In the Viewport Alignment (ALIGNSPACE) command, the ability to align any viewport to the alignment points specified in one of the available viewports has been added.

## Arc Text Command

A new **Arc Text** (ARCTEXT) command allows you to create **Arc Text** type objects along a curve selected arc.



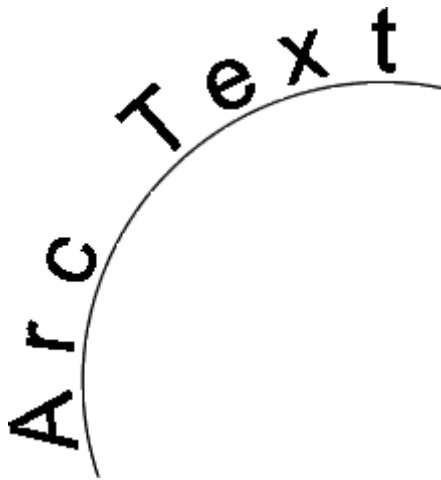
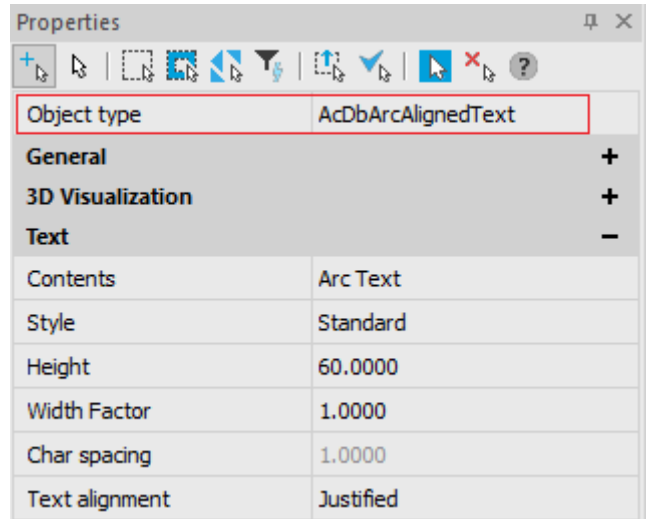
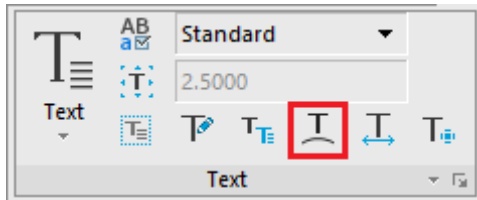

Arc text options can be specified and edited both in the **Properties** bar and in the **ArcAligned Text Settings** dialogue box.

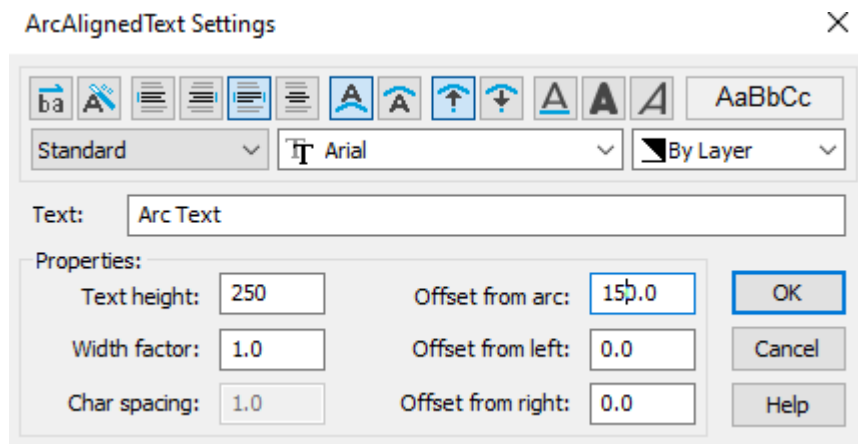

The arc text is associated with the arc along which it is built. It changes its position and stretch with the change in the length and curvature of the arc itself.

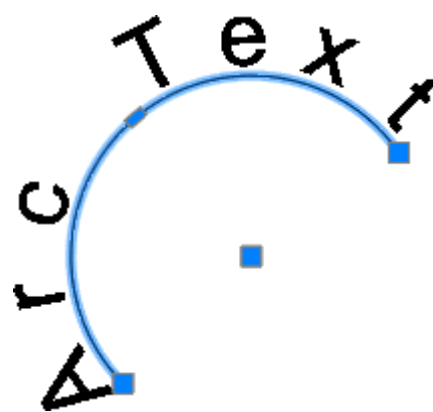
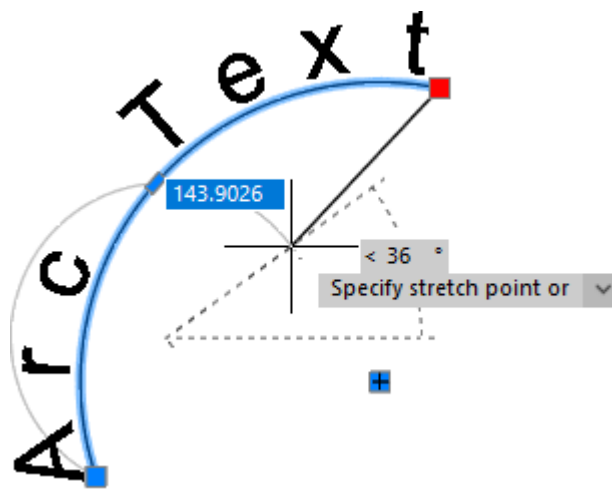

The arc text has its own grips that allow you to adjust the value of its offset above/below the arc and the offset along the arc from its left or right edge.

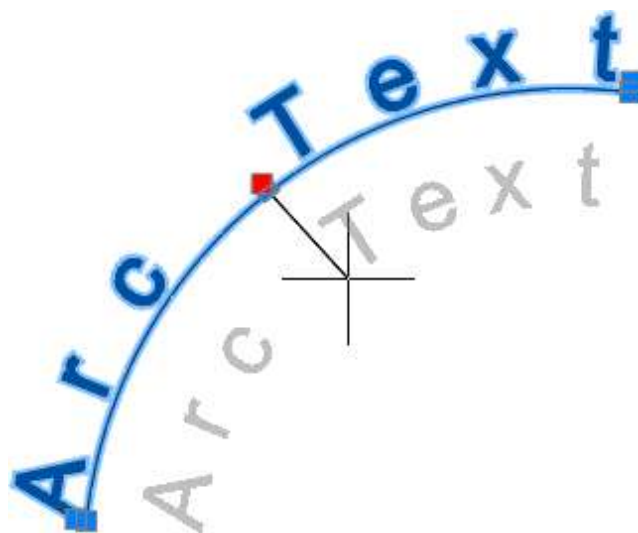

## Rectangle from Center Command

A new **Rectangle from Center** (RECTCENTER) command allows you to create a rectangle (**Polyline** object) by specifying its center and vertex.

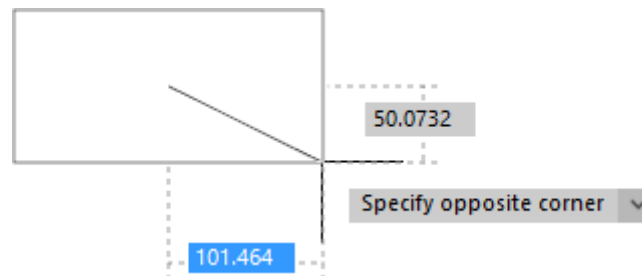
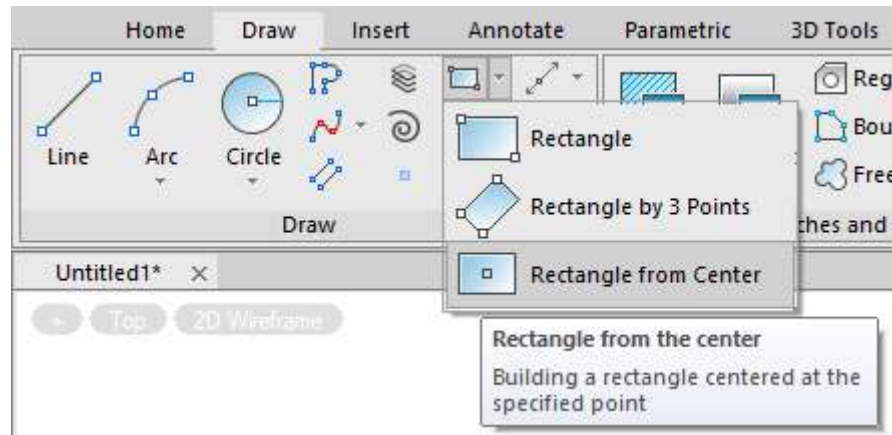

When creating it, you can specify the length, width, area, rotation angle, chamfer size or corner rounding value.

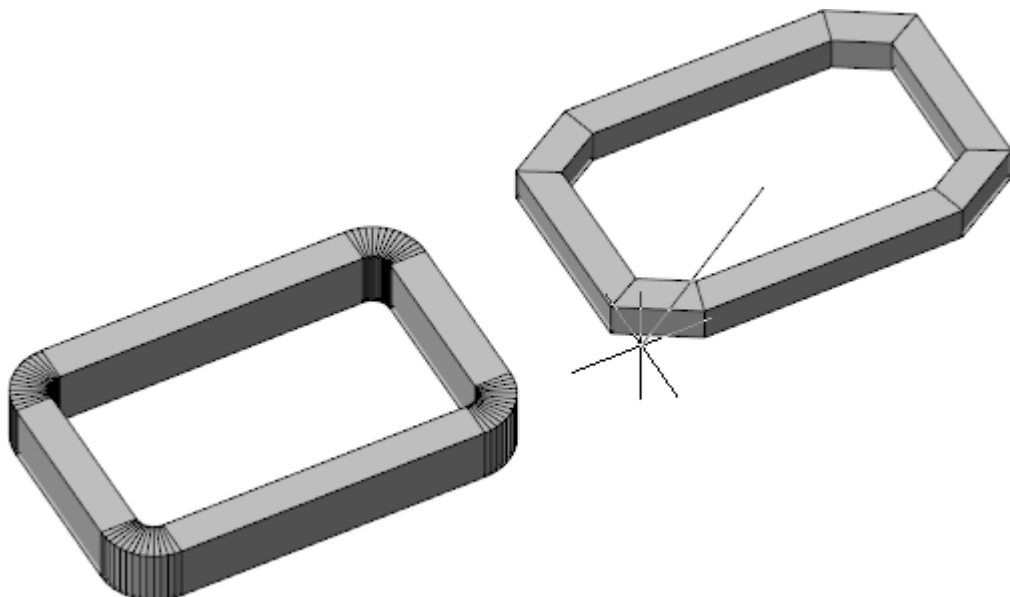

## Layer Options in the Drawing Explorer

In the **Drawing Explorer** it has become possible to view and change layer properties. The following icons are displayed: current layer, xref layer, on/off, unfrozen/frozen, layer color.

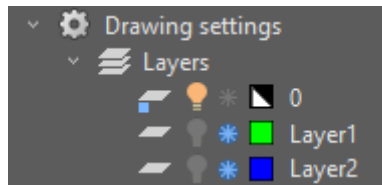

By clicking on the icon while holding down the CTRL key, you can switch layer options such as on/off, thawed/frozen. Double clicking on a layer sets it current.

## Multiline Text Editing Restart Mode

The multiline text editing command MTEXTEDIT, MTEDIT is set to automatically restart at the end of the previous session. The final completion of the work is carried out by pressing the ESC key. You can switch to a single command call by selecting the **Mode** option, and then **Single**.

```

X Command: MTEXTEDIT
MTextEdit - Edit Multiline Text
Select MText object or [?/Mode]: Mode
Select an edit mode of text [Multiple/Single] <Multiple>:
  
```

The **Mode** option switches the value of the new system variable TEXTEDITMODE, which controls the automatic repetition of the MTEXTEDIT command.

- **0 – Multiple.** Enables automatic repetition of the MTEXTEDIT command.
- **1 – Single.** Specifies the MTEXTEDIT command to edit a single text object.

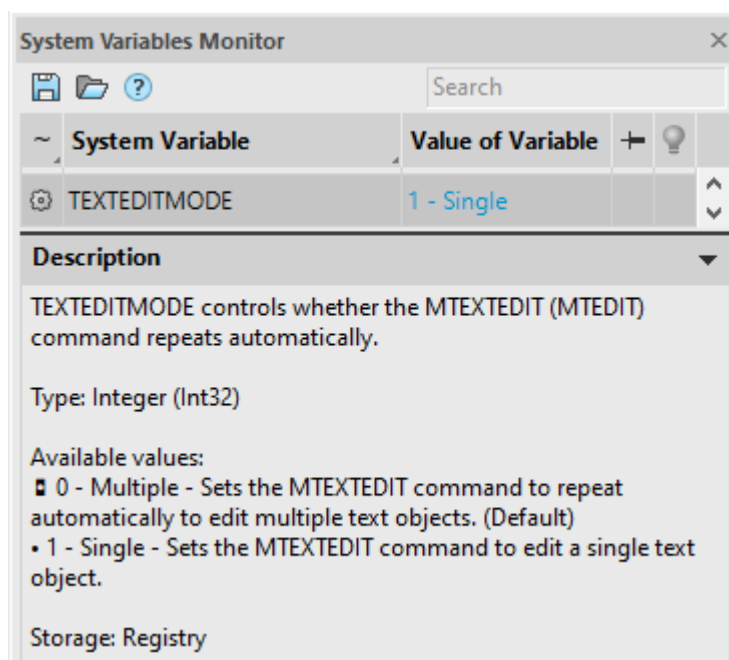

## Text Character Spacing

The Tracking button has been added to the multiline text editing bar, which allows you to set the character spacing:

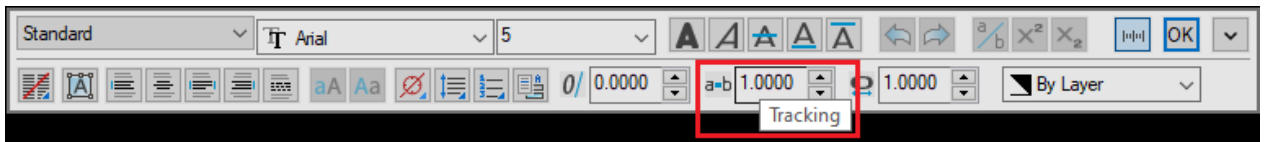

## Dimensions

A new property of **Automatically control the measurement scale in the viewport** has been implemented, available for dimensions specified in the layout.

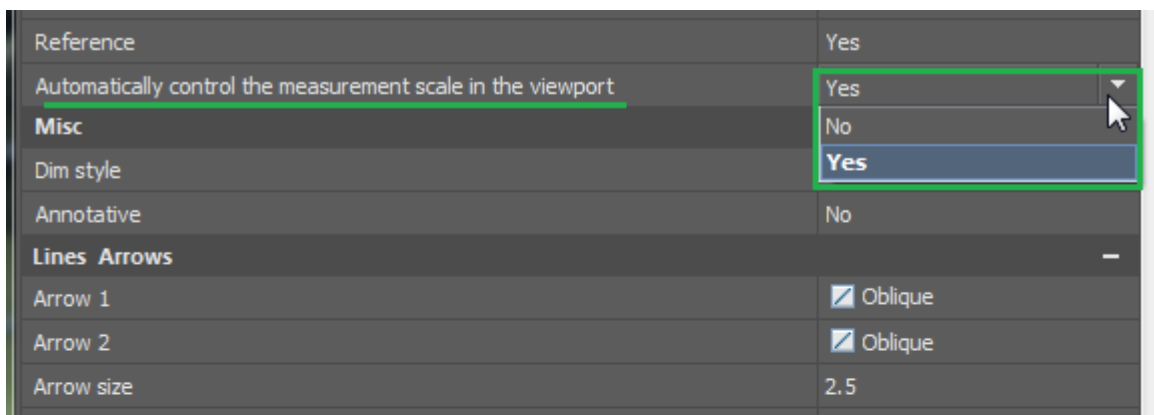

In the context menu of the selected dimension, you can now control its precision:

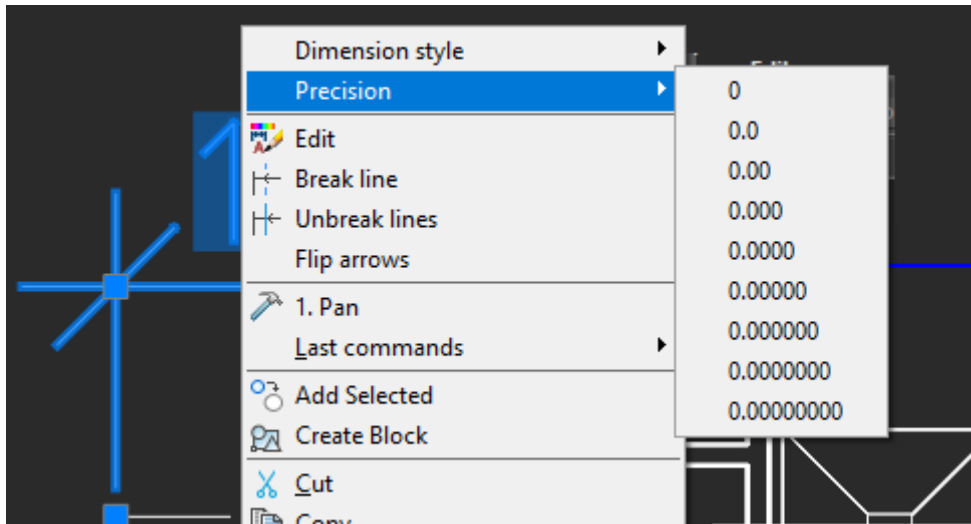

## Copying Hatch Background

The copy object properties command (MATCHPROP) now copies hatch background.

## Aligning Raster Image

Now highlighting is removed from a raster image when it is aligned with the ALIGN command. This makes specifying points on the raster for alignment more convenient.

## Import of Page Setups in the Batch Print Dialog

In the **Batch Plot** dialog box, it became possible to import page setups from external drawing files (\*.dwg), drawing template files (\*.dwt), graphics interchange format files (\*.dxf), CAD standards files (\*.dws).

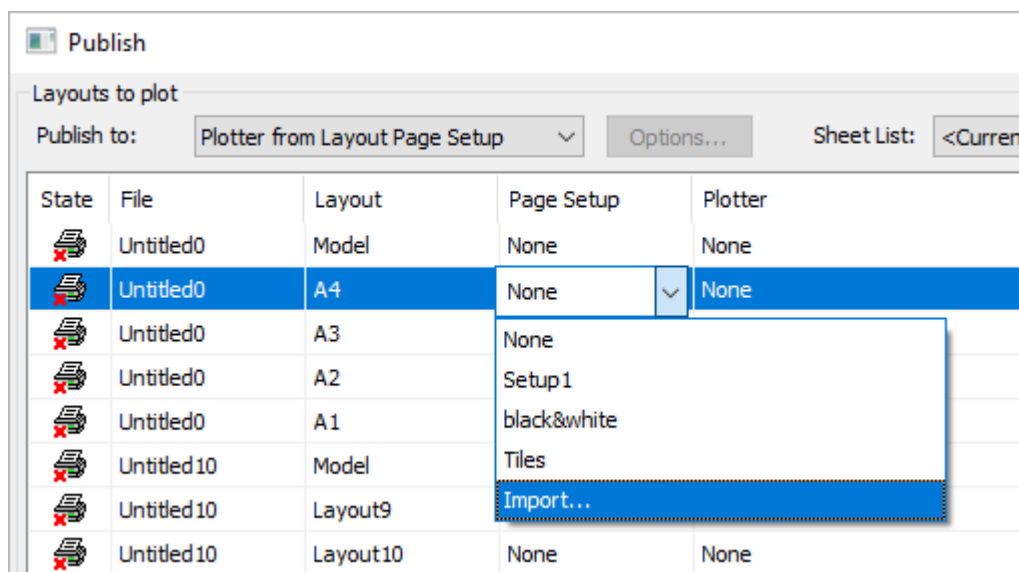

A set imported in this way is displayed as **Imported: <Setup\_name>** in the Page Setup drop-down list:

State	File	Layout	Page Setup	Plotter
	nCAD. Gradient	Model	None	None
	nCAD. Gradient	A4	Imported: Page Setup	Internal PDF Plotter
	nCAD. Gradient	A3	None	None
	nCAD. Gradient	A2	None	
	nCAD. Gradient	A1	Setup1	
	Untitled0	Model	Imported: Page Setup	
	Untitled0	A4	Import...	
	Untitled0	A3	None	None

## Sorting in the Batch Plot Window

The alphanumeric sorting by file and layout names in the **Batch Plot** dialog has been improved. Now, even if the names of files or layouts contain numeric values, they are correctly sorted in ascending and descending order. For example, Layout10 will appear after Layout9 and before Layout11, and not between Layout1 and Layout2 as before.

Example of sorting a list by file name.

In this case, the names of layouts are displayed not in ascending or descending order, but in the order in which they are arranged in their files.

Example of sorting a list by layout name.

In this case, the file names are also arranged in ascending-descending order.

Layouts to plot

Publish to: Plotter from Layout Page Setup

State	File	Layout	Page Setu
	Untitled0	A1	None
	Untitled0	A2	None
	Untitled0	A3	None
	Untitled0	A4	None
	Untitled0	Model	None
	Untitled9	Layout9	None
	Untitled9	Layout10	None
	Untitled9	Layout11	None
	Untitled9	Layout19	None
	Untitled9	Layout20	None
	Untitled9	Layout21	None
	Untitled9	Model	None
	Untitled10	Layout9	None
	Untitled10	Layout10	None
	Untitled10	Layout11	None

Layouts to plot

Publish to: Plotter from Layout Page Setup

State	File	Layout	Page Set
	Untitled0	A1	None
	Untitled0	A2	None
	Untitled0	A3	None
	Untitled0	A4	None
	Untitled9	Layout9	None
	Untitled10	Layout9	None
	Untitled9	Layout10	None
	Untitled10	Layout10	None
	Untitled9	Layout11	None
	Untitled10	Layout11	None
	Untitled10	Layout12	None
	Untitled9	Layout19	None
	Untitled9	Layout20	None
	Untitled9	Layout21	None
	Untitled0	Model	None

## Disabling Layer Information when Printing to PDF

Now there is the possibility to turn off layer information when printing to PDF. The **Include Layer Information** option has been added to the **Internal PDF Plotter** Setup dialog. Its disabling can optimize further work with PDF files.

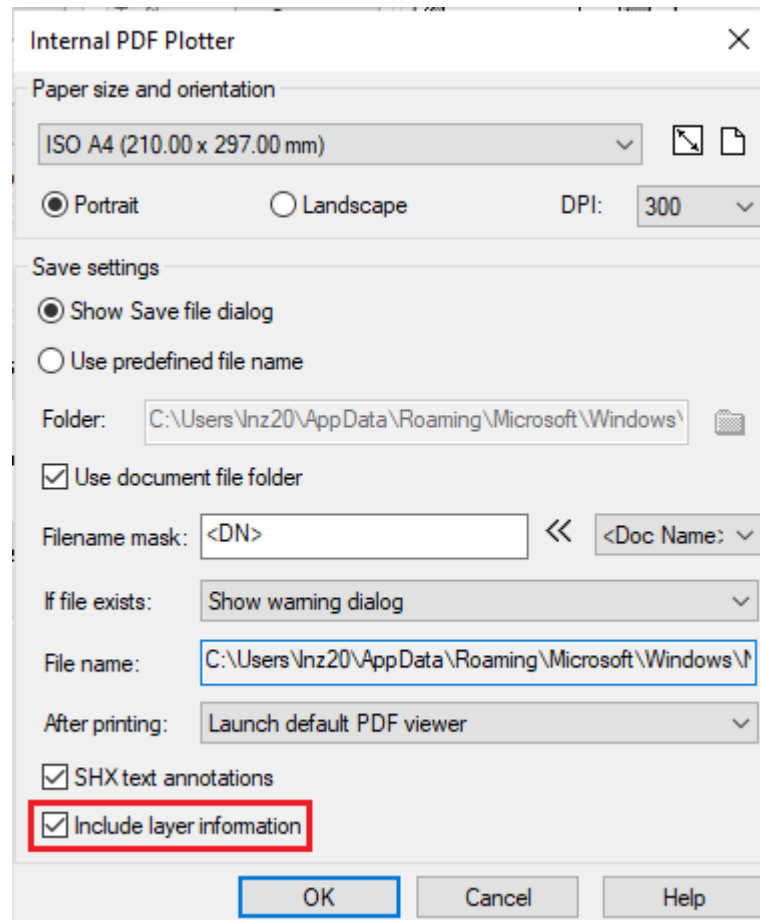

## Removing Duplicate Objects when Importing PDF

In the **Import PDF** (PDFIMPORT) dialog, the **Remove duplicate objects** option has been added, its disabling can speed up file import.



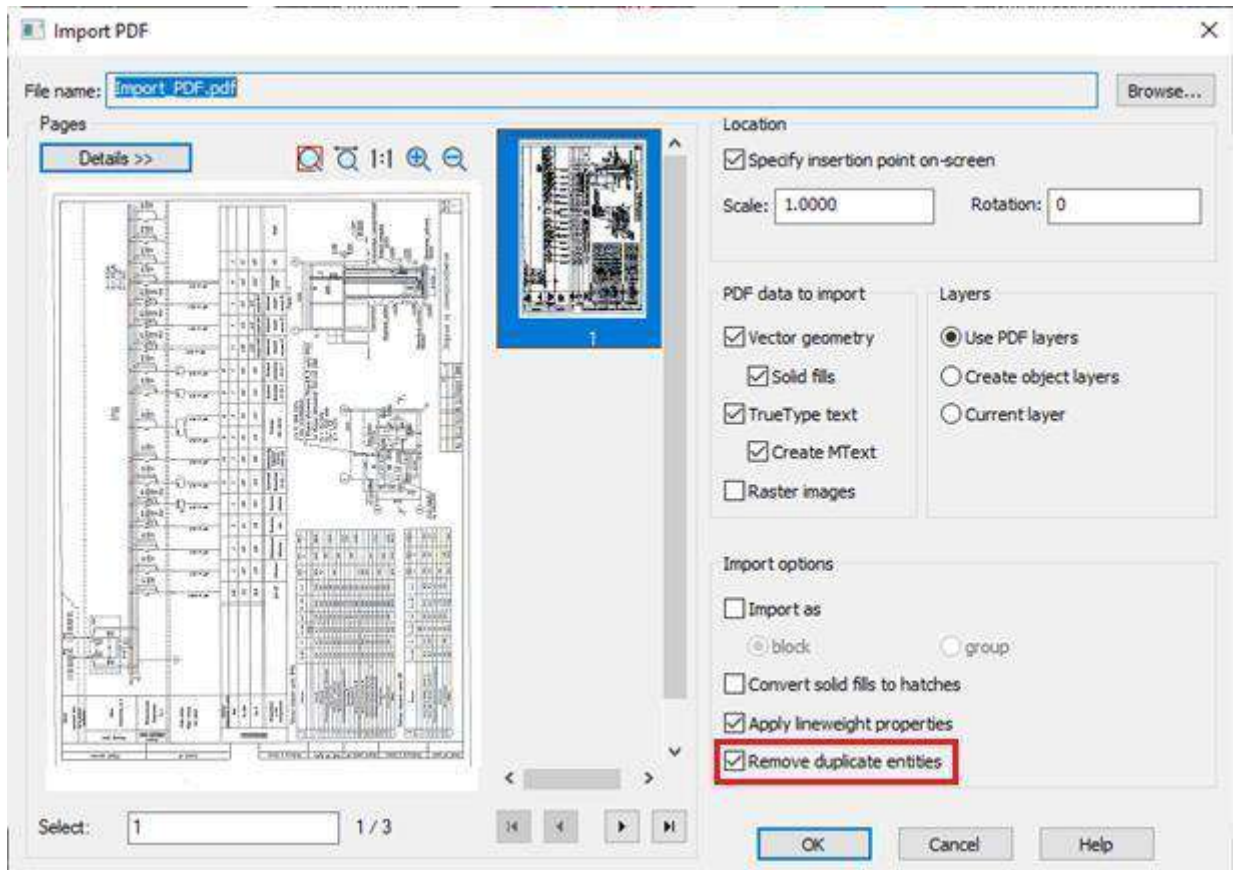

## Bounding Prism by Selection

A new command MCLIPBYSELECTION creates a bounding prism taking the prior selection into account.

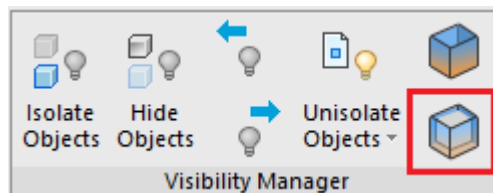

The command builds a bounding prism around the selected objects according to the size of their common overall rectangle.

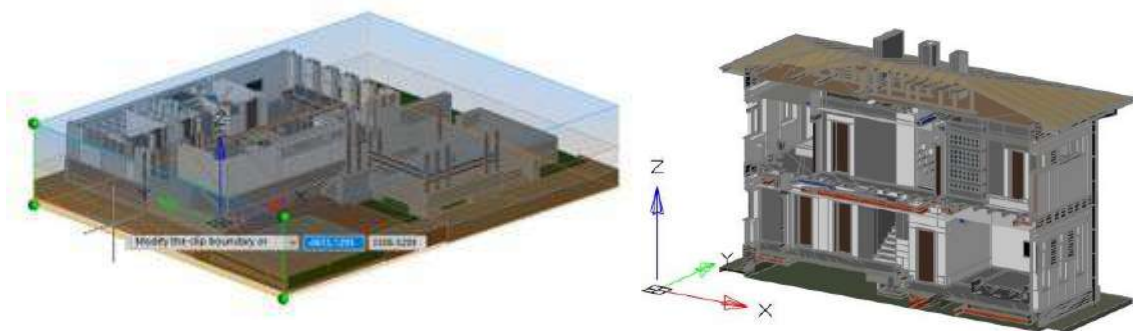

You can edit the created prism with the MCLIP command.

## UCS by 3D Object Face

With the new **Face** option, the **UCS** command allows you to view and align the UCS to any face of a 3D object. In this case, the **Dynamic UCS** mode (F6) should be enabled. The new UCS is displayed when you hover over a face.

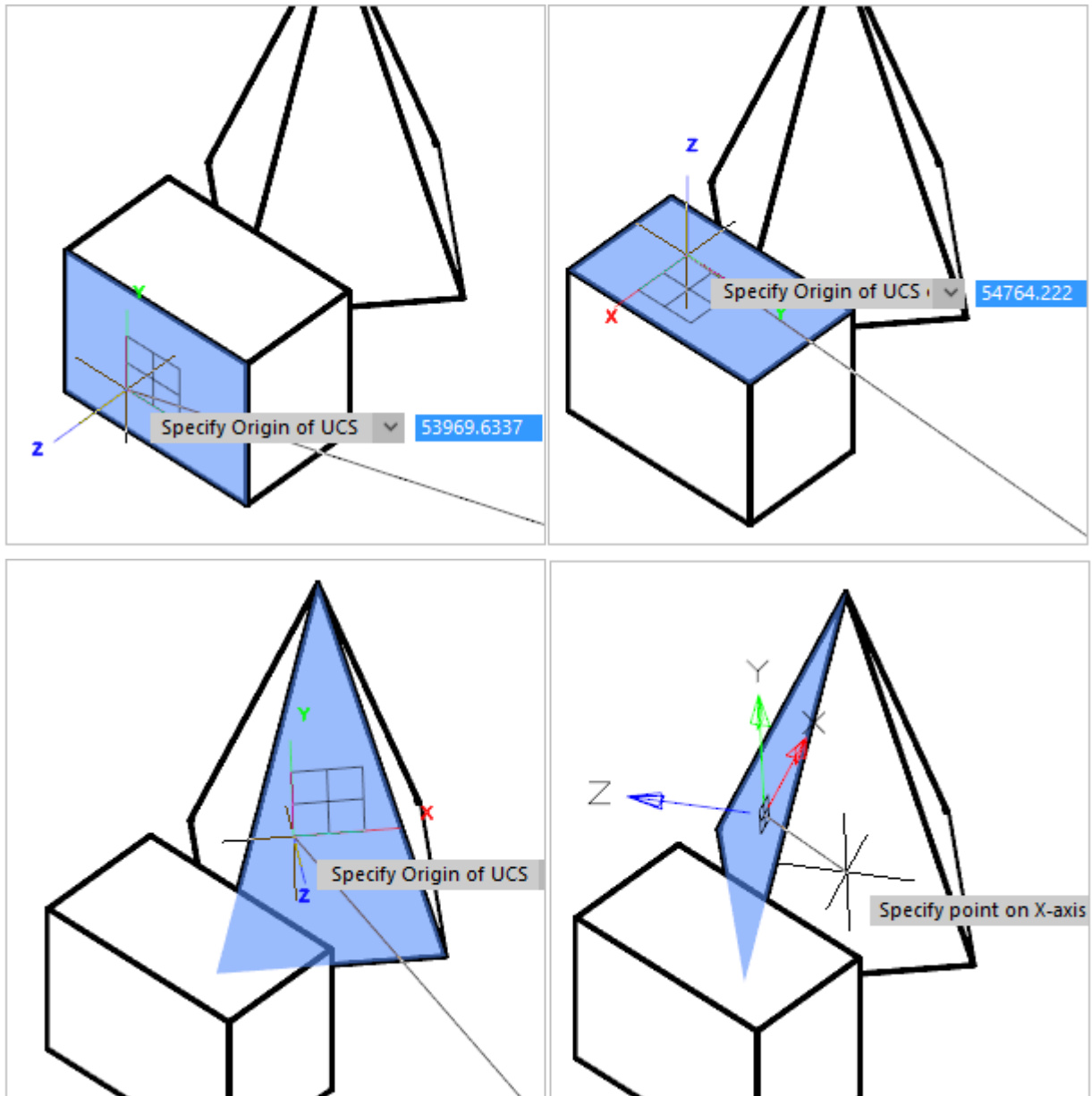

In the process of aligning and changing the coordinate system with the UCS command, there is a UCS preview icon near the cursor that allows you to visually evaluate the changed direction of the coordinate system axes.



## DUCS when Specifying a Vertex

In previous versions of nanoCAD, the dynamic UCS mode allowed specifying the UCS plane on the screen only once during the work of draw/edit command (when requesting the first vertex). Further queries and drawings were carried out in the same UCS, until the command completion.

Now, a new UCS plane can be specified during any next request for coordinates. To do this, in the process of specifying the vertex, you need to hold down the key combination **CTRL+~**.

To make the UCS dynamic setting mode work automatically with each request for coordinates without holding down the keys, you should assign the value 1 to the UCSDETECTMODE variable (default = 0).

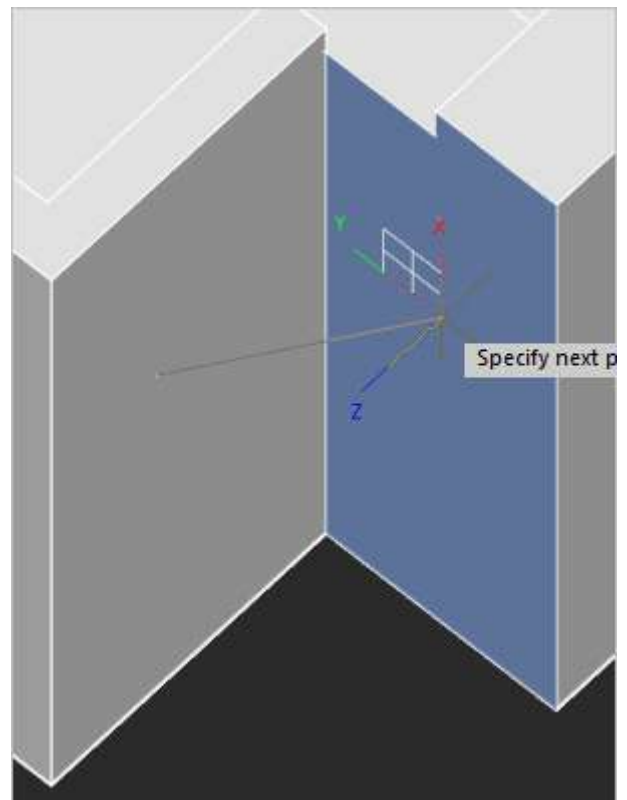
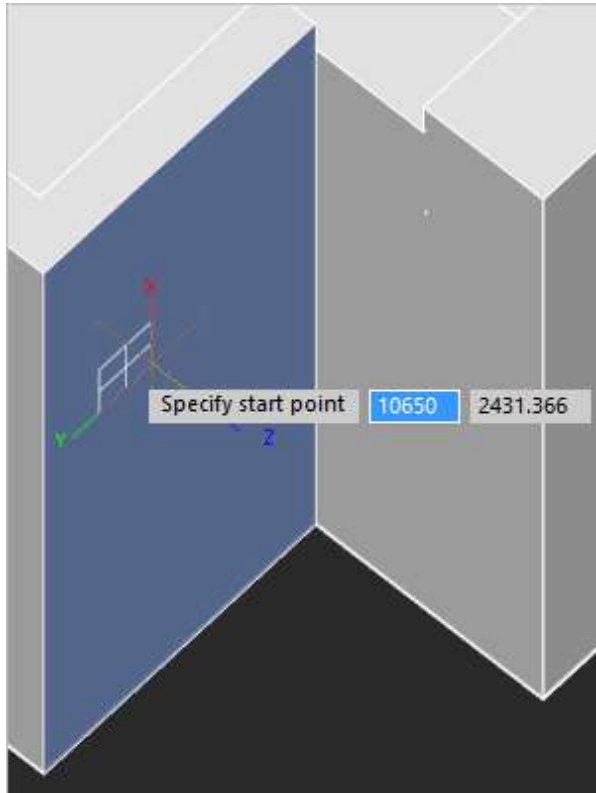

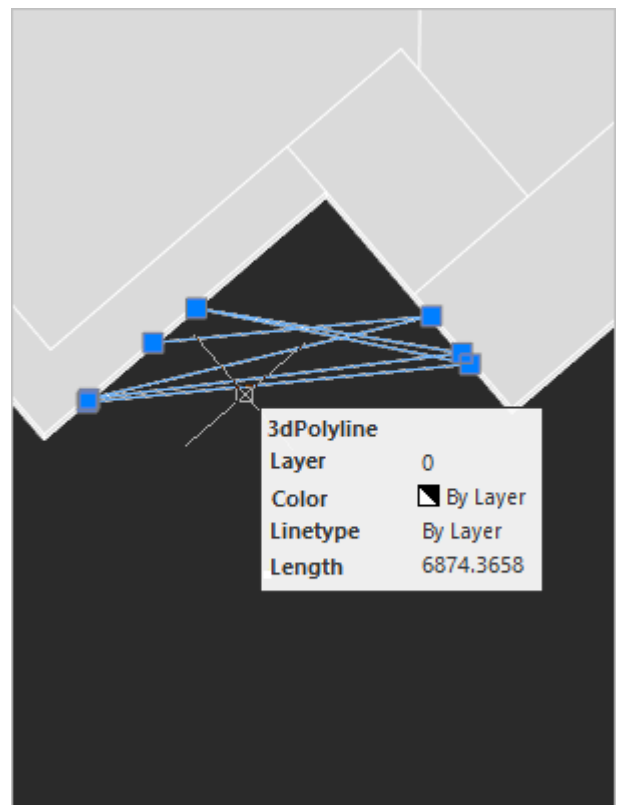
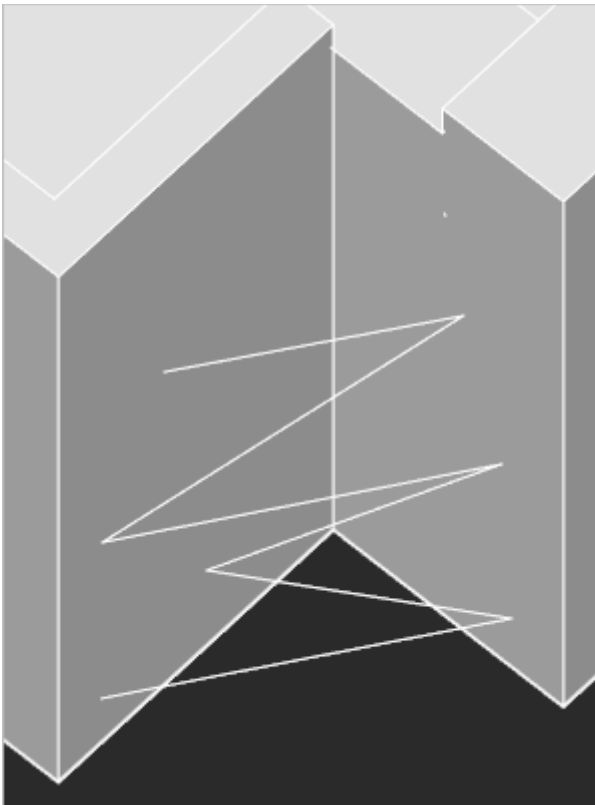
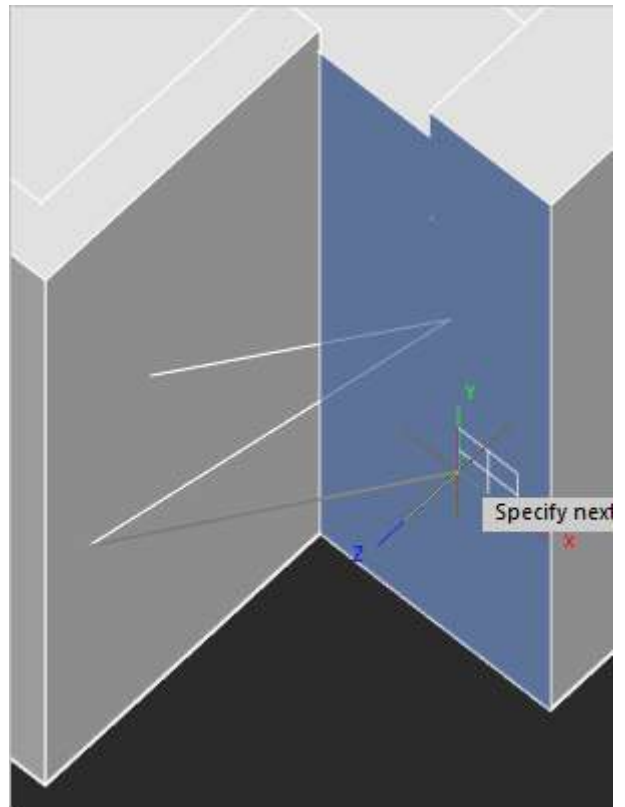
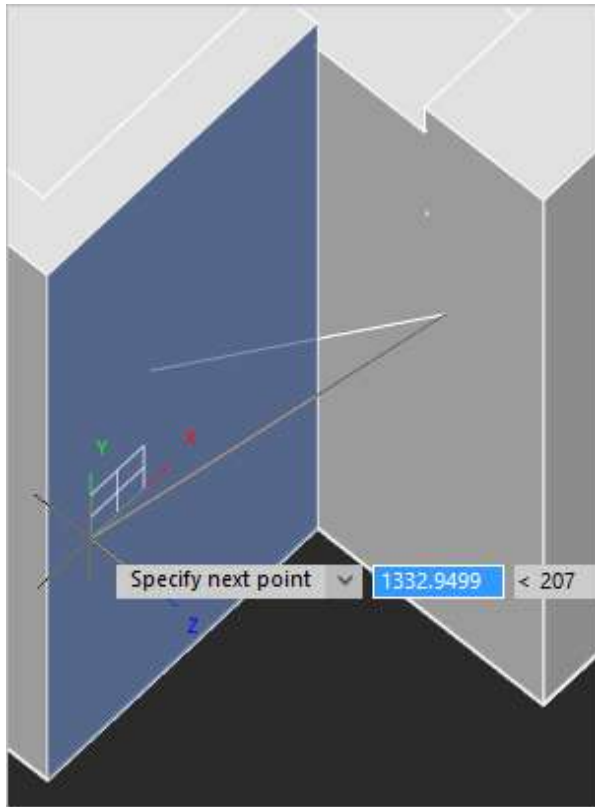

## Rotating the model with the Mouse Wheel

The settings for rotating the model with the mouse wheel in the **Options** dialog have been redesigned and have become more understandable. You can disable or assign mouse wheel rotation (with or without SHIFT) and set the model's rotation speed.

The rotation speed varies from 25% to 400% of the nominal value. The default value is 300%:

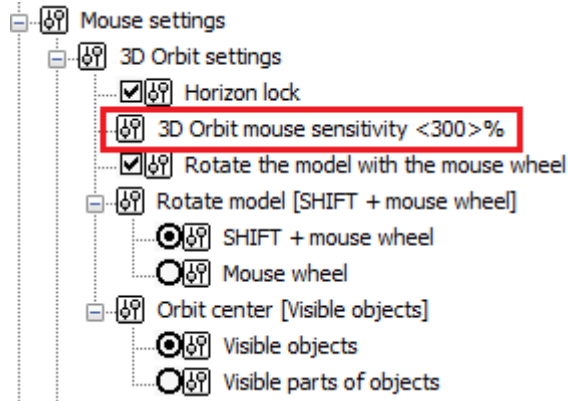

The **Rotate the model with the mouse wheel** checkbox allows you to disable the model rotation with the mouse wheel. If enabled, clicking the mouse wheel (with or without SHIFT) will be used to rotate the model with the **Orbit** command launched in transparent mode. If the setting is disabled, pressing the mouse wheel will not rotate the model. Only panning will be performed.

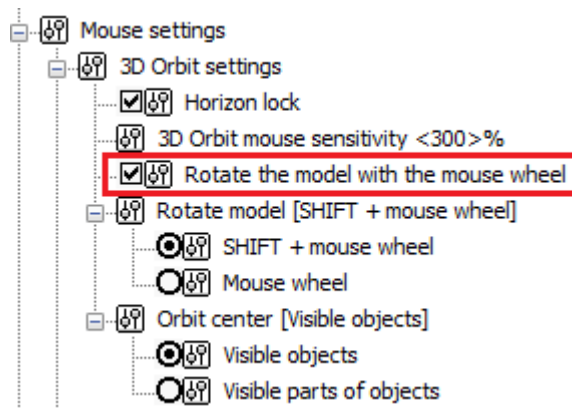

The **Rotate model** section allows you to select one of the usual ways for the user to control the orbit: by clicking on the mouse wheel or by pressing the mouse wheel while holding down the SHIFT key. Rotation will be performed only when the **Rotate the model with the mouse wheel** box is checked.

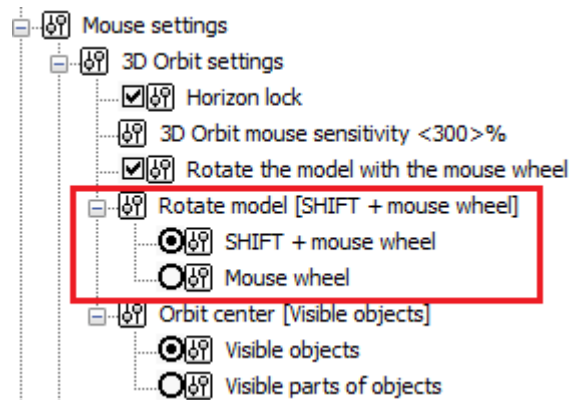

## IFC Import

Now it has become possible to import large IFC files (1 GB or more).

In addition, when importing an IFC file, the IFC architectural objects are now automatically classified by layers.

## Lengthening Smooth Polylines

In the **Lengthening** (LENGTHEN) command in the **Dynamic** mode, polylines are extended/shortened in one or both directions not only for the extreme segments, but for the entire polyline. The **Dynamic** mode is now also available for polylines with quadratic and cubic smoothing.

## Selecting and editing polyline segments

The **Polyline** object now has the possibility to select individual segments while holding down the CTRL key (or SHIFT+CTRL, depending on the selection mode).

The selected segments have functional grips that can be used to edit them.

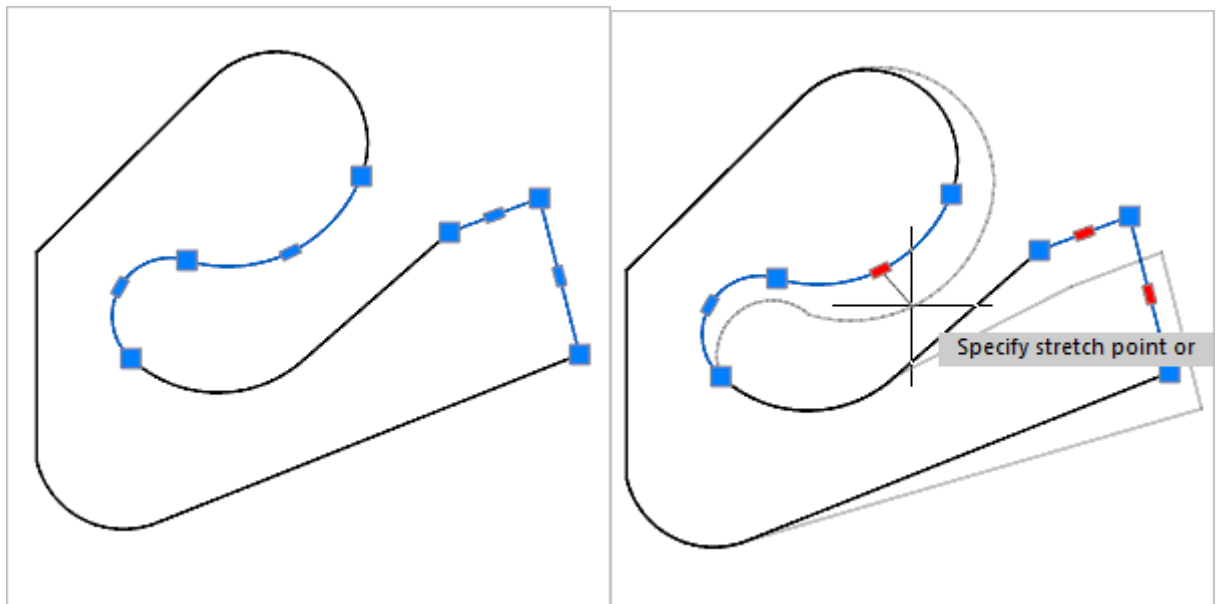

The selected segments can be moved, rotated and scaled with standard editing commands **Move** (MOVE), **Rotate** (ROTATE) and **Scale** (SCALE).

You can delete such segments, including internal ones, with the formation of remaining polyline objects.

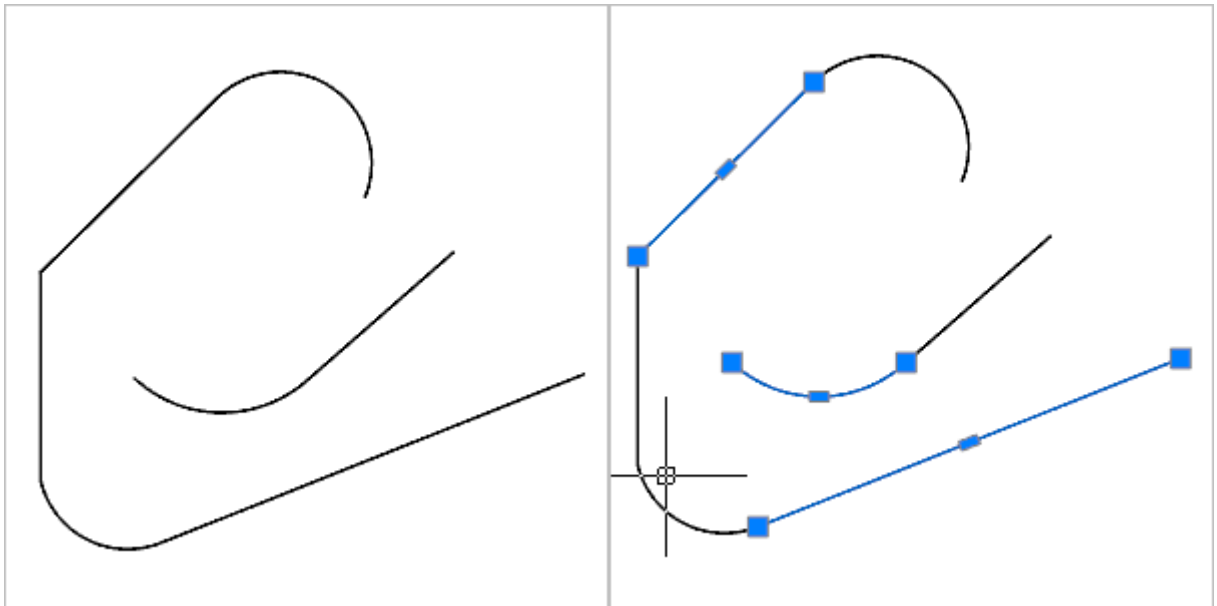

### 3D Knot and Vertex Snaps to Spline

The work of 3D snaps to spline of **Knot** and **Vertex** type.

The **3D Knot Snap** finds fit points on a spline created by fit points.

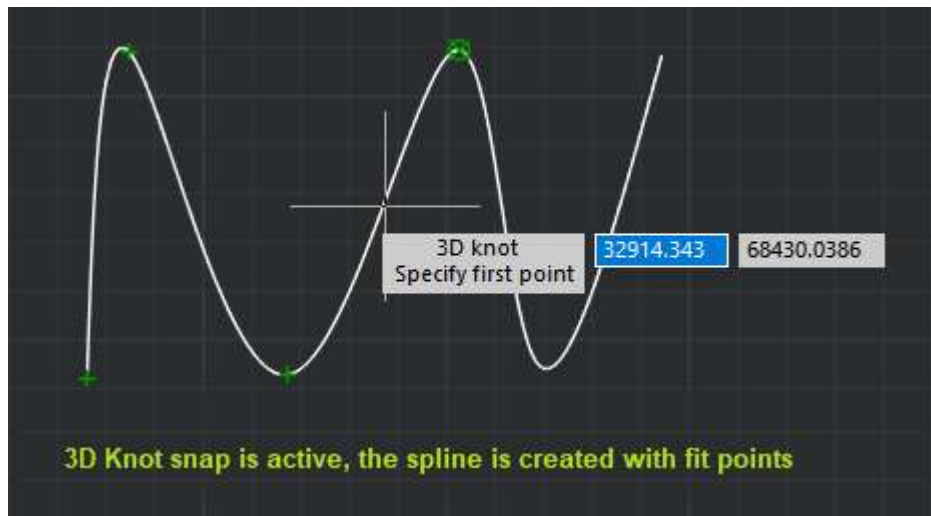

The **3D Vertex Snap** finds control vertices on a spline created from control vertices.

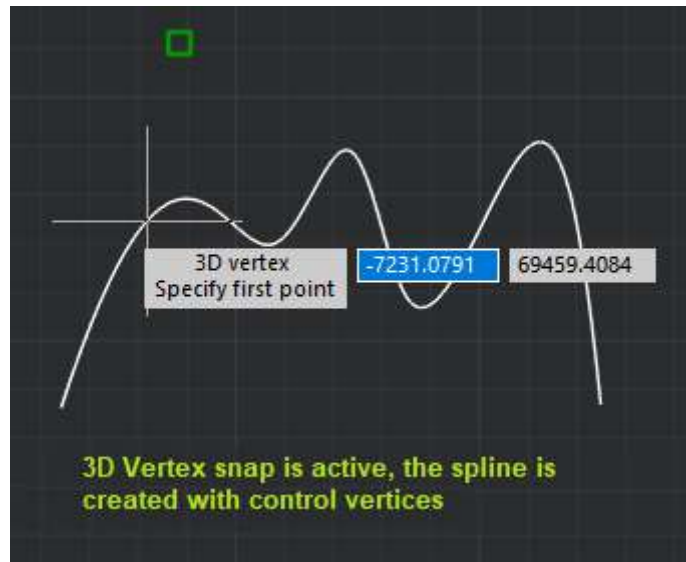

## Create a Document from the Command Line

The new QNEW command is designed to create a document from the command line without having to switch to the non-dialog mode (FILEDIA=0).

## Non-Dialog Version of the -ATTEXT Command

A non-dialog variant of the command for extracting data (text) from attributes to a file -ATTEXT has been implemented for use in scripts.

```

X *cancel*
Command: -ATTEXT
Enter extraction type or enable object selection [Cdf/Sdf/Dxf/Objects] <C>:

```

## Copying Properties

The **Copy Object Properties** (MATCHPROP) command now has the possibility to copy layer property overrides in the viewport.

## Select Group Command Button

A button for the Select Group (PGROUP) command has been added to the interface. The button is located in the **Group** section of the **Home** tab of the ribbon interface and on the **Group** bar of the classic interface.

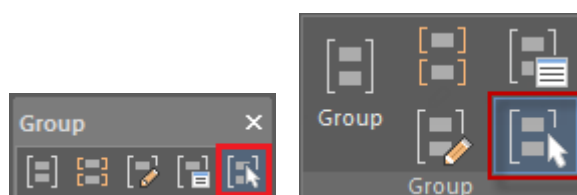



The button switches the value of the PICKSTYLE variable to 0 or 1:

- 0 – No group selection, the object included in the group is selected;
- 1 – When you select an object in a group, all objects in the group are selected.

## Selection Dialog Button

The display mode button of the **Selection** dialog has been moved to the status bar.



The **Selection** dialog opens when you click on objects that are very close to each other (or directly on top of each other) to specify which of them should be selected.

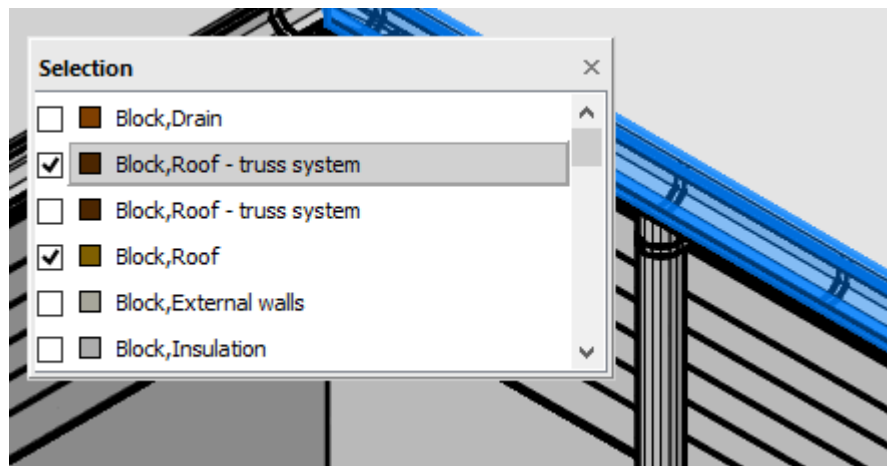

## Switching the ribbon content

For developers of vertical applications, a mechanism for switching the content of the ribbon tab without using system variables has been implemented, similar to the mechanism for switching the content of the **3D Tools** tab using the modeling mode buttons.

You can describe such a switch and the content of each tab option using special commands. In the CFG file, you should use the ribbon tab content switching commands. The connection between the content and the switcher is configured by the **ribbon\_condition** value in the ribbon tab description XML file, which is set in the CFG file by the **set\_ribbon\_condition** command by the **keyword** value specified in it.

XML Example:

```
<RibbonTabSource UID="ID_Org1" ribbon_condition="K1" Text="New tab" alias="text">
  <RibbonPanelSourceReference PanelId="ID_switcher" ResizeStyle="Default">
  </RibbonPanelSourceReference>
  <RibbonPanelSourceReference PanelId="ID_content1" ResizeStyle="Default">
  </RibbonPanelSourceReference>
```

</RibbonTabSource>

CFG Example:

```
\configman\commands\Command-1] | weight=i1 | cmdtype=i1 |  
RealCommandName=sset_ribbon_condition | BitmapDll=snewbtns.dll | StatusText=s |  
TooltipText=s | LocalName=s | intername=s1 | keyword=sK1 | DispName=sFirst variant
```

## Improved Search in the Interface Settings Window

The search for tools in the **Customize User Interface** (INTERFACE) dialog box has been improved. Commands are now proposed as you type in the search bar, similar to how command selection works in the command line.

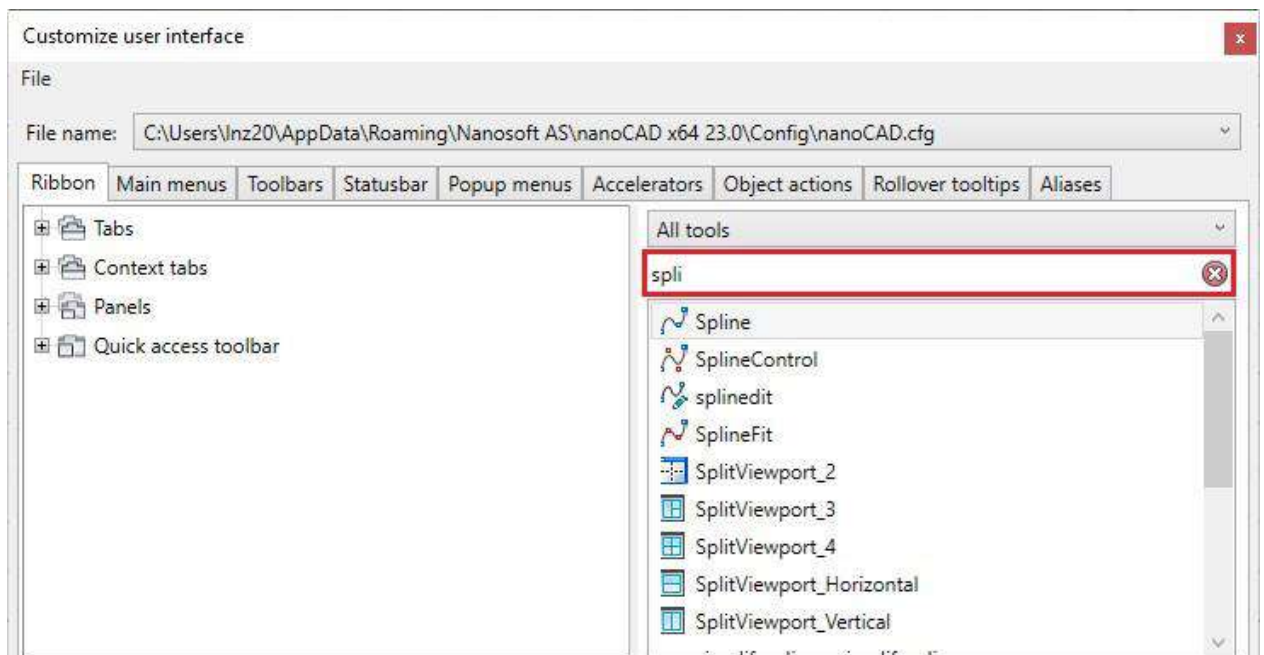

## Inserting an Underlay by Control Points

The **Map Underlay insertion** (MAPVIEW) has been improved. Now it is possible to insert raster cartographic underlays **By control points**. When this option is selected, a dialog opens that allows you to specify the corresponding points in the drawing and on the raster.

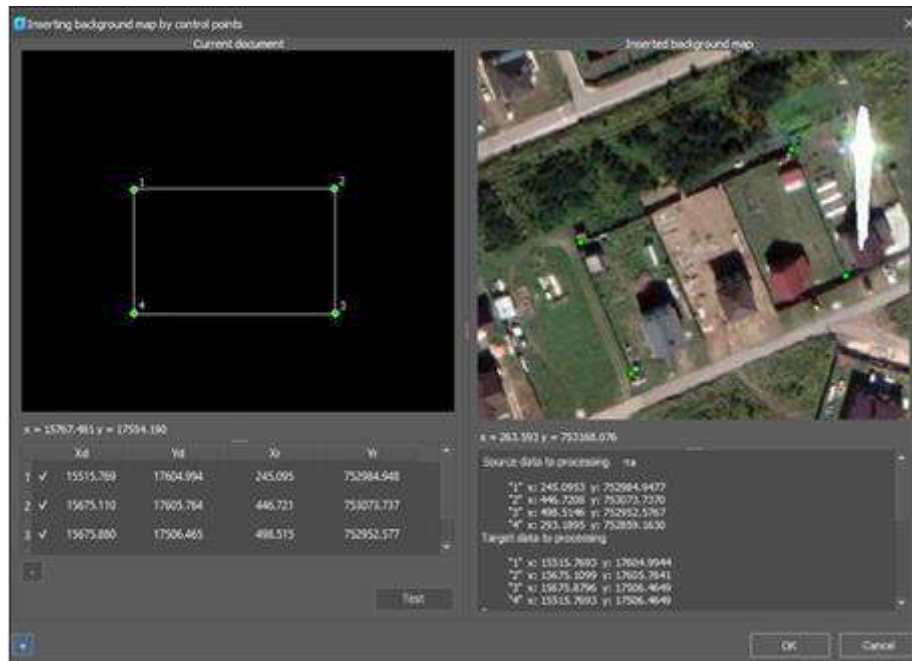

## Multiple xrefs Insertion

Simultaneous insertion of multiple DWG files as xrefs has been implemented.

After running  **DWG Reference** command, select several DWG files in the dialog that opens holding down CTRL and SHIFT keys.

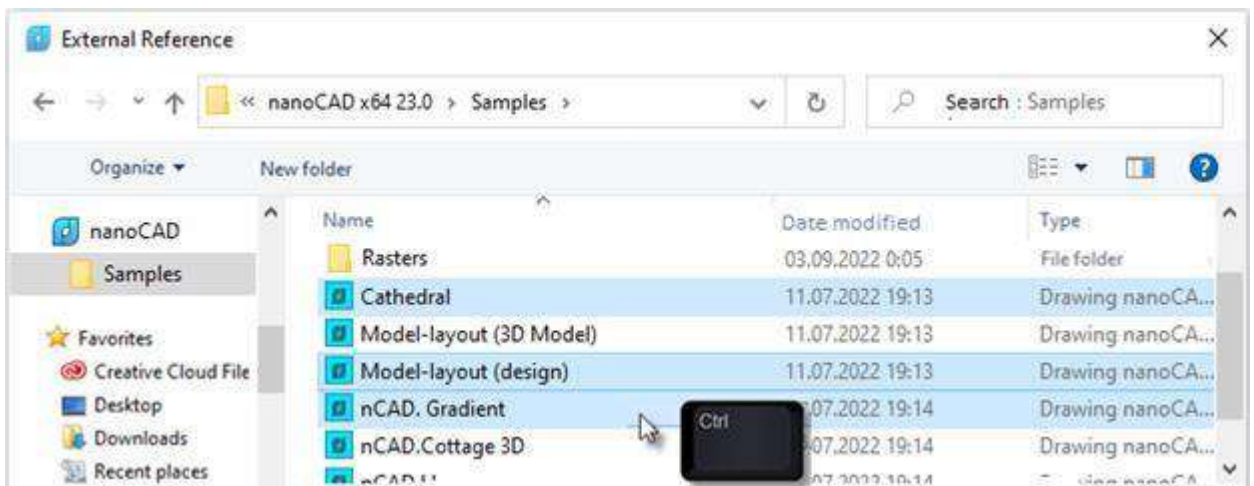

In the **Internal Reference** dialogue, configure the insertion parameters and click OK.

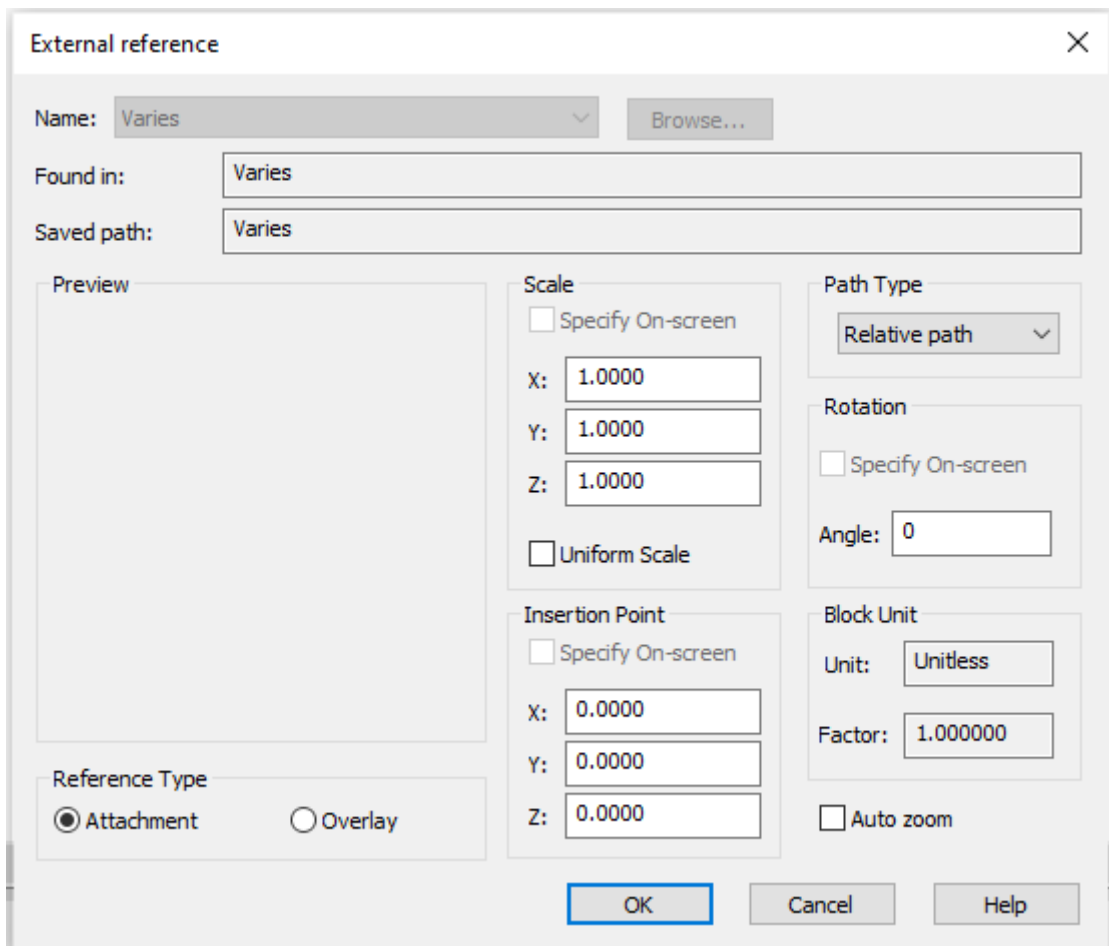

The selected files will be inserted as external references with the specified parameters.

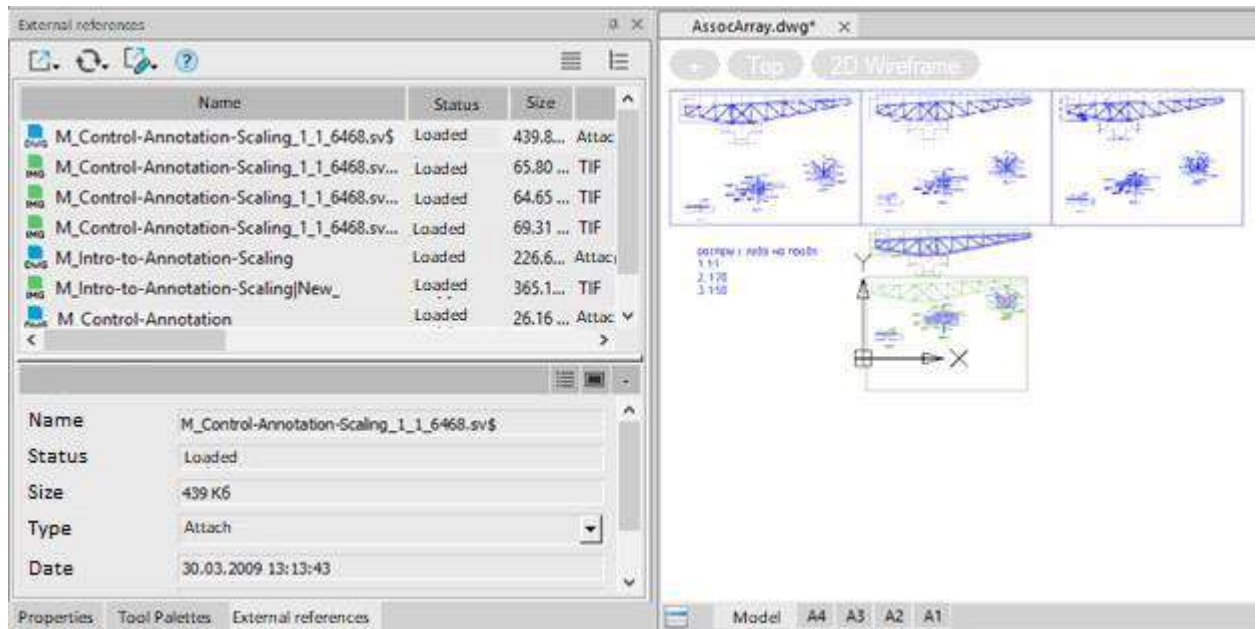

## Highlighting External References in a Drawing

The external references selected in the **External References Dialog Box** are now automatically selected and highlighted in the drawing. Conversely, when selecting xref objects in a drawing, their names will

automatically be selected in the **External References Dialog Box**. Single and multiple selection supported (using CTRL and SHIFT):

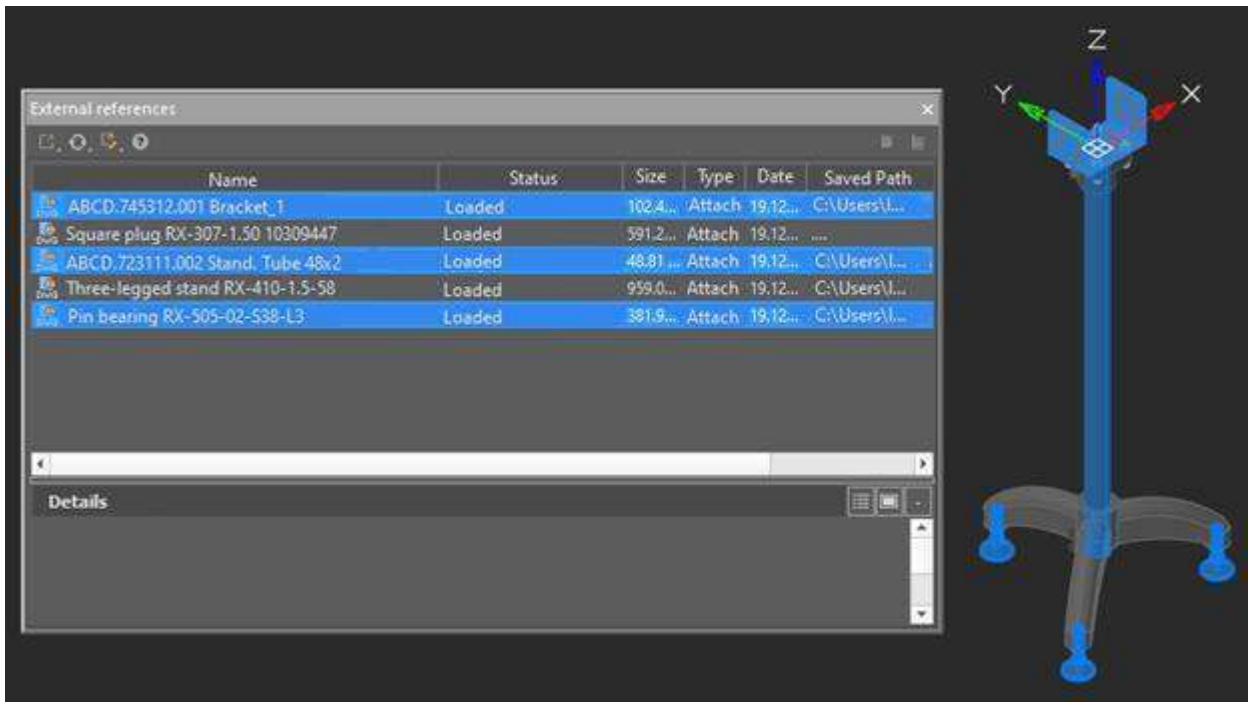

The new ERHIGHLIGHT system variable is responsible for highlighting objects in a drawing that are selected in the **External References Manager**. If the value is 0, only the names of references in the manager window are highlighted, if the value is 1, the corresponding objects in the drawing are highlighted.

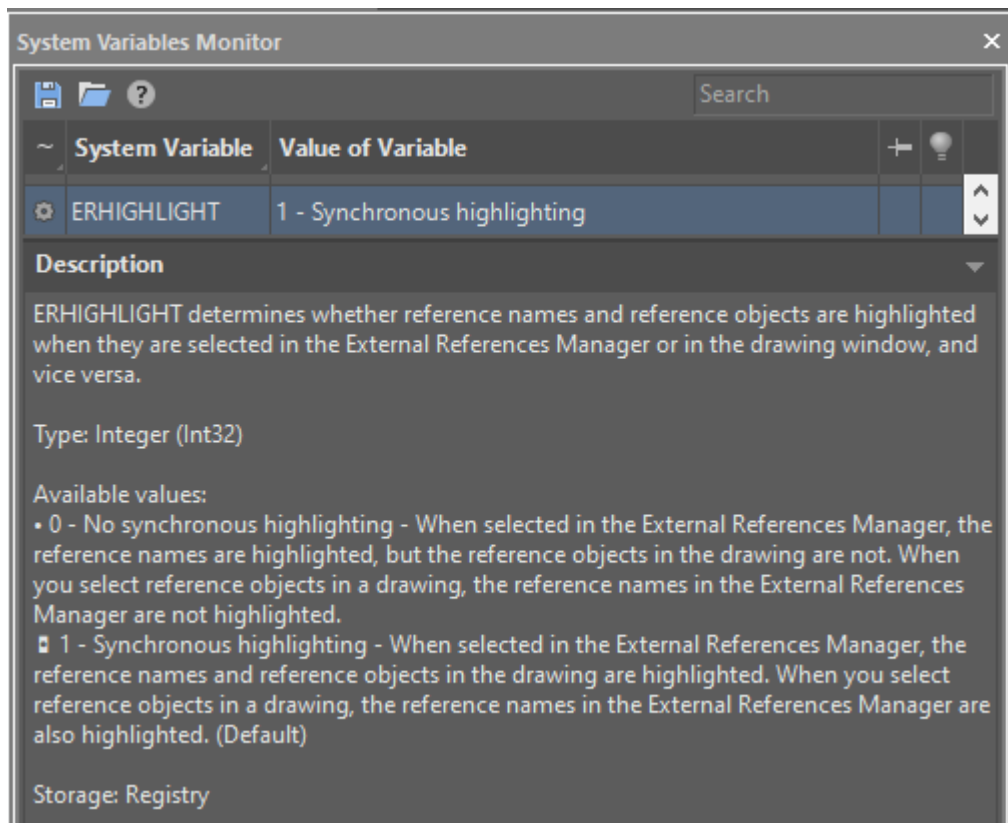

## New Commands in the External References Dialog Box

In the **External References Dialog Box**, **Reload All References** and **Select all** commands have been added in the context menu:

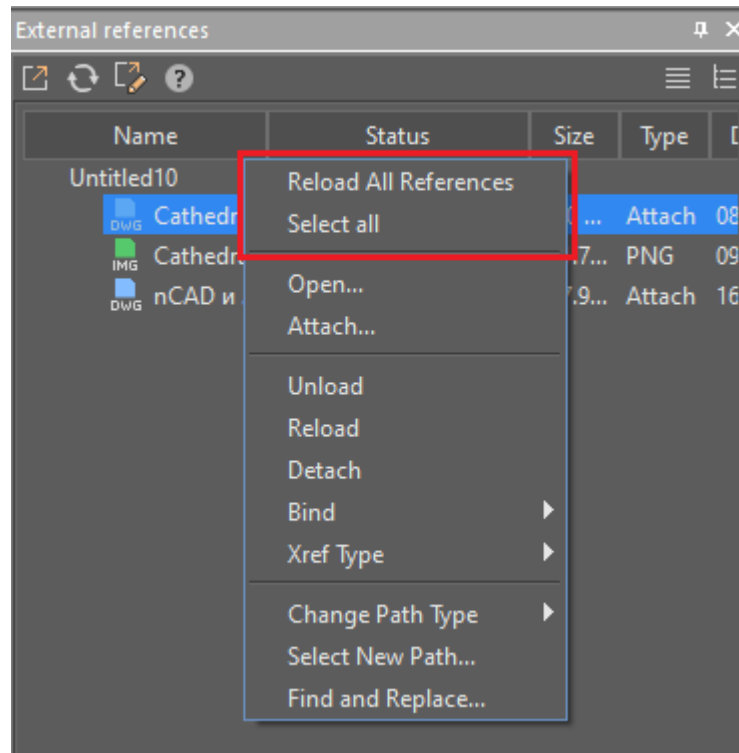

## FIXED BUGS

### Corrections in the Work of Multiline Texts

The bug due to which some characters of the Indian alphabet were shifted in the blueprint has been fixed.

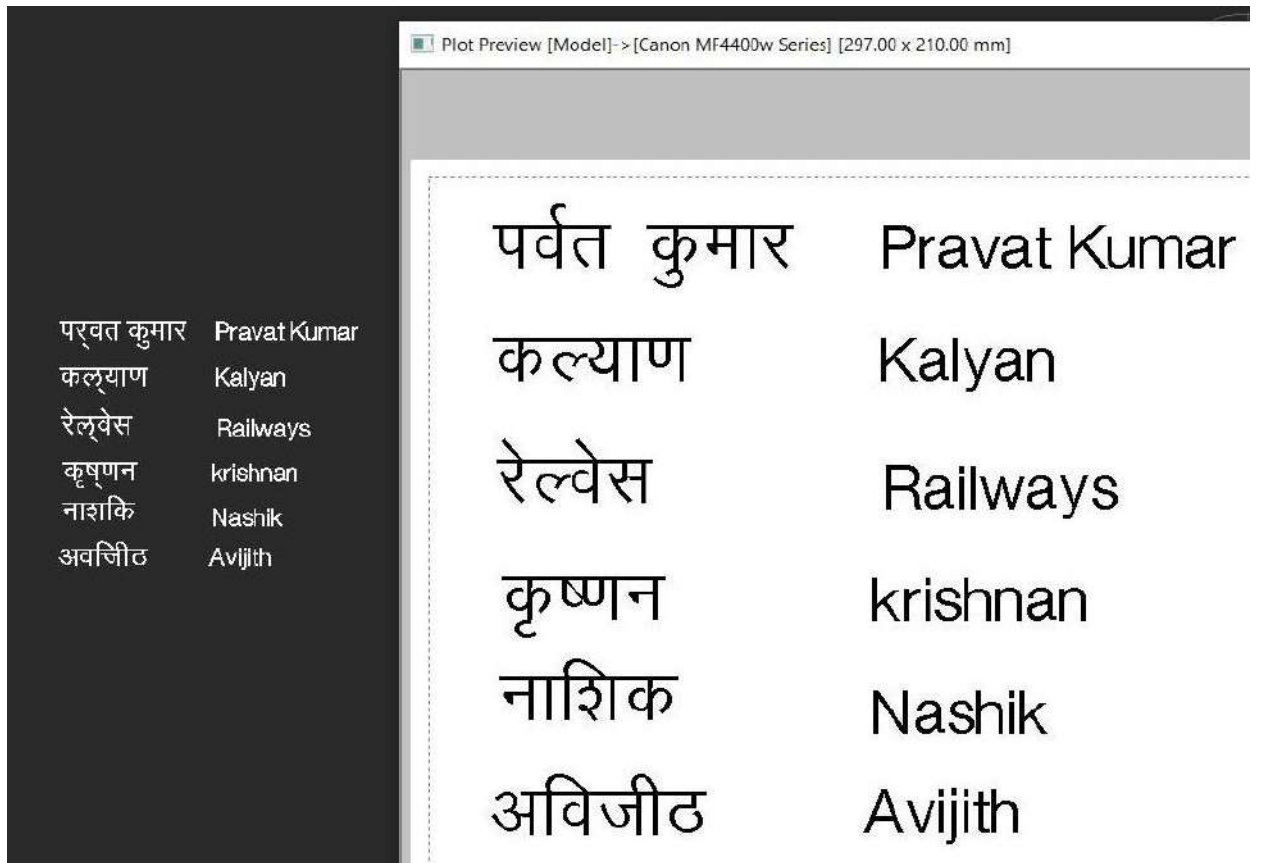

The bug due to which the Arabic letters “broke up” in a drawing and in the editor has been fixed. Now the characters remain merged, and the text is readable.

## Corrections in Work with Text and Attributes

Now, when editing a multiline attribute (EATTEDIT), the display of the remaining block objects persists (both for the value of the variable ATTIPE=0, and for ATTIPE=1).

The bug due to which hiding the background of multiline text in Model space did not work in a user file has been fixed.

The **Find and Replace** command (FIND) has been improved. Now she not only finds, but also replaces text in multileaders.

## Corrections in Work with PDF Files

The bug that caused the built-in PDF printer to not print a drawing viewport when it had positional leaders whose text crossed the viewport boundaries has been fixed.

The bug due to which a PDF file obtained after printing a user DWG file with a large number of entities by the internal PDF plotter was drawn slowly in the PDF viewer has been fixed.

The bug that in a particular case led to multiple duplication of objects in the drawing when importing a user PDF file has been fixed.

The bug and program slowdown caused by inserting multiple PDF files as an underlay in a user DWG file have been fixed.

## Corrections in Graphics Display

The bug that in a particular case caused the multileader to shift in the user file after editing it has been fixed.

The bug that caused part of a large raster image not to be displayed in the drawing has been fixed.

The bug that caused applied dimensions to shift when entering the viewport of a user DWG file has been fixed.

The defects that in a particular case led to errors in displaying objects, dimensions and loss of associativity of dimensions in the user file have been fixed.

## Fixing the Work of Snaps

The bug in the behavior of the **Quadrant** object snap for a circle and an arc has been fixed. Now, if a circle or an arc was drawn in the UCS rotated relative to the WCS, the **Quadrant** snap will only work when they are in that UCS. At the same time, for an ellipse, the snap will work in both UCS and WCS.

The bug as a result of which, when drawing objects on the top face of a 3D solid using 2D snaps, unwanted snap to fit points of the bottom face occurred, has been fixed.

## Fixes and Improvements when Drawing

The corner reference point when drawing an arc in **Center, start, corner** mode. Now the countdown is from the point of specifying the beginning of the arc.

Switching edit modes of the **Region** object using the round grip now only happens for a specific object, even if there are several objects in the selection.



The bug that, in a particular case, led to impossibility to select objects in a user file using a crosshair, frame, or cutting box has been fixed.

The bug that caused the measurement scale to change when switching from a paper to a model in a user file has been fixed.

## Corrections in Work with Non-DWG Files and from Other CAD Programs

The bug that in a particular case led to the error **The operation was not completed and the file was not created. Empty ACIS not allowed: <AcDb3dSolid>(63)** when trying to save a user STEP file.

The bug due to which files restored in version 20.1 stopped opening in another CAD program has been fixed. Files oversaved in version 23, 21.0 and 22.0 now open in another CAD program without recovery.

The bug that caused a multileader landing offset in a user file with UCS that was created in another CAD program has been fixed.

The bug of the FILLET command that made it impossible to set the cropping mode to zero radius has been fixed.

The default width of the **Name** and **Status** columns in the **External References Manager** has been increased.

## Plot Corrections and Work with Layouts

An abnormal program termination when switching layouts if a non-current sheet was previously deleted programmatically has been fixed.

Incorrect work with the following printers has been fixed:

- HP Designjet T770
- Konica minolta bizhub C224e
- HP Designjet T1100

The bug where between calls to the **Plot** command driver settings that did not depend on the options set in the **Plot** dialog were not saved for any external plotters has been fixed. Driver settings that do not depend on the options set in the **Plot** dialog are driver-specific settings. For example, type of paper (plain, photo, film), paper tray, toner save mode, etc.

Appearance of bold lines in Model space after assigning a plot style and checking the **Display plot styles** box in the **Plot** dialog has been fixed:

- Draw a couple of lines in the model and open an existing file;
- Open the Plot dialog and set any Plot style table;
- Check the **Display plot styles** box;
- Click **Apply to layout** and close the plot dialog;
- Switch to any layout, return to the model.

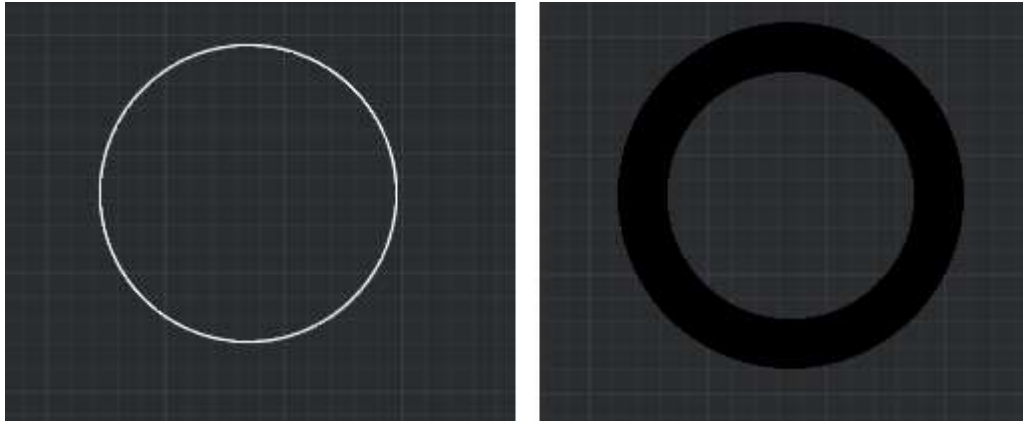

Bug fixed: The HP DesignJet driver setup dialog appeared behind the nanoCAD window and was therefore not visible to a user.

The situation, when with the running progress indicators **Check Printer Papers** and **Check Application Defined Papers**, it was possible to uncheck/check boxes in the **Plot** dialog, call dialogs (for example, for creating layout options set, settings) has been fixed.

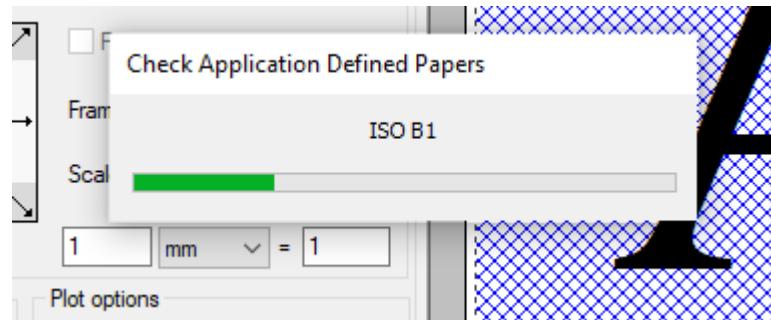

The **Insert Layout from Template** (LAYOUTFROMTEMPLATE) command has been fixed. Layouts were not created if there were proxy objects in the template.

The work of the non-dialog plotting command (-PLOT) has been fixed:

- Plot settings were not saved when answering Yes to the prompt: Save changes to page setup? Or set shade plot quality?
- The prompt Plot layout objects first? was processed incorrectly when printing a layout. In case of Yes answer, the Layout objects last option was set, though it should have been removed. In repeated printing, No reply was proposed by default instead of Yes.

- The No value for the Display Plot Styles option did not work.

In the **Plotter Properties** dialog the **Apply to layout** button has been replaced to **OK** button, which better reflects the essence of the action and excludes the confusion with **Apply to layout** button in the **Plot** main dialog. The **Plotter Properties** dialog opens from the **Plot** dialog after opening an external plotter settings with its further completion by **OK**.

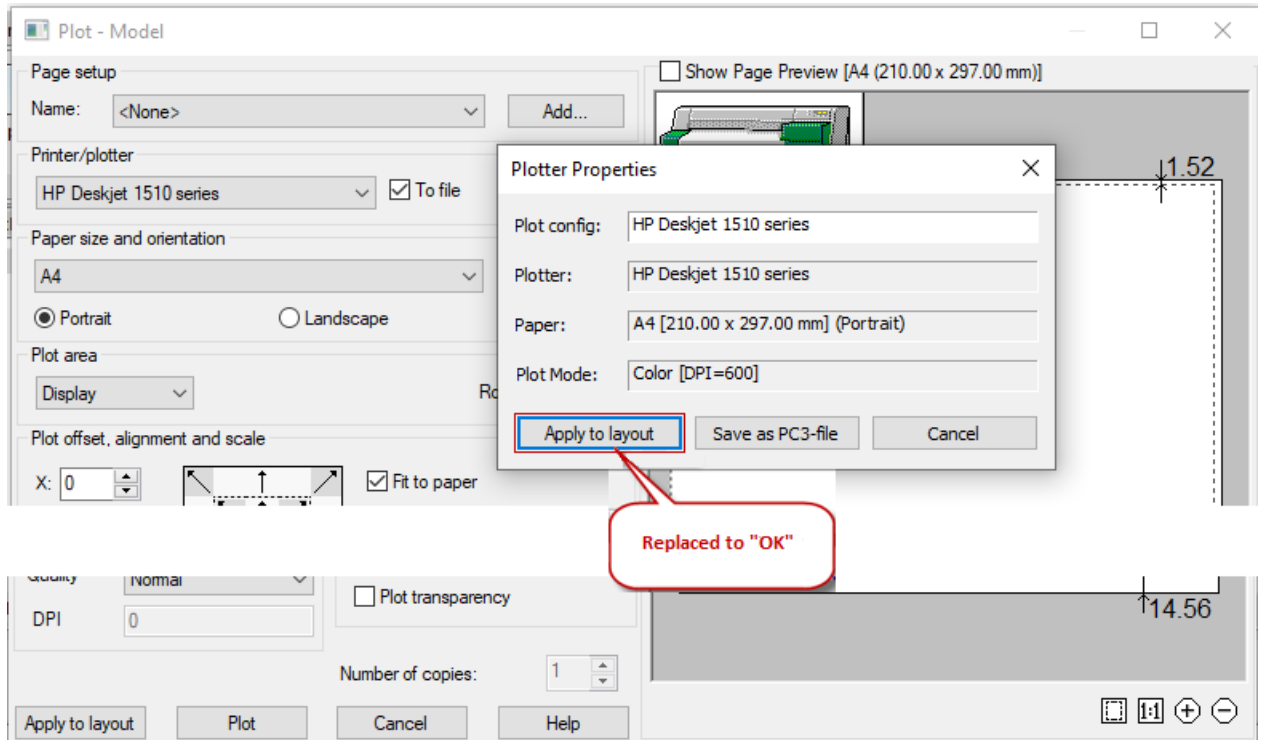

In the preview window of the **Plot** dialog, text clipping at the size of the print margins has been fixed.

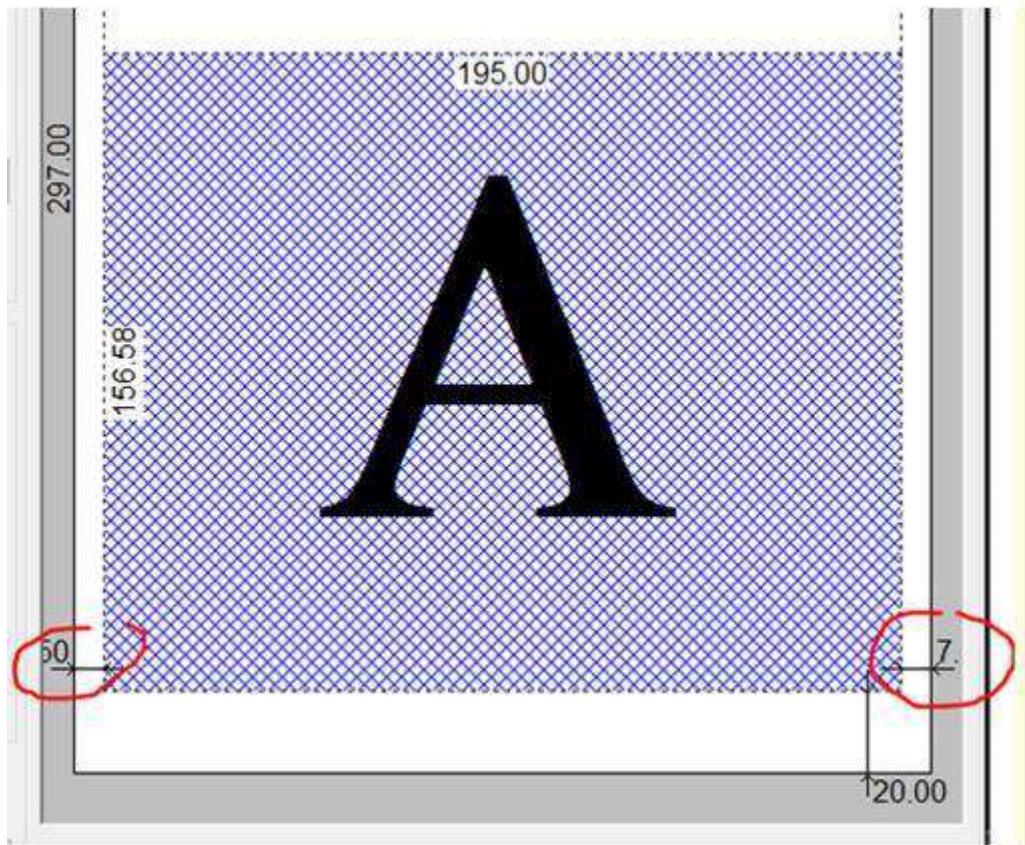

Incorrect display of paper format sizes in the print preview window for small formats has been fixed.

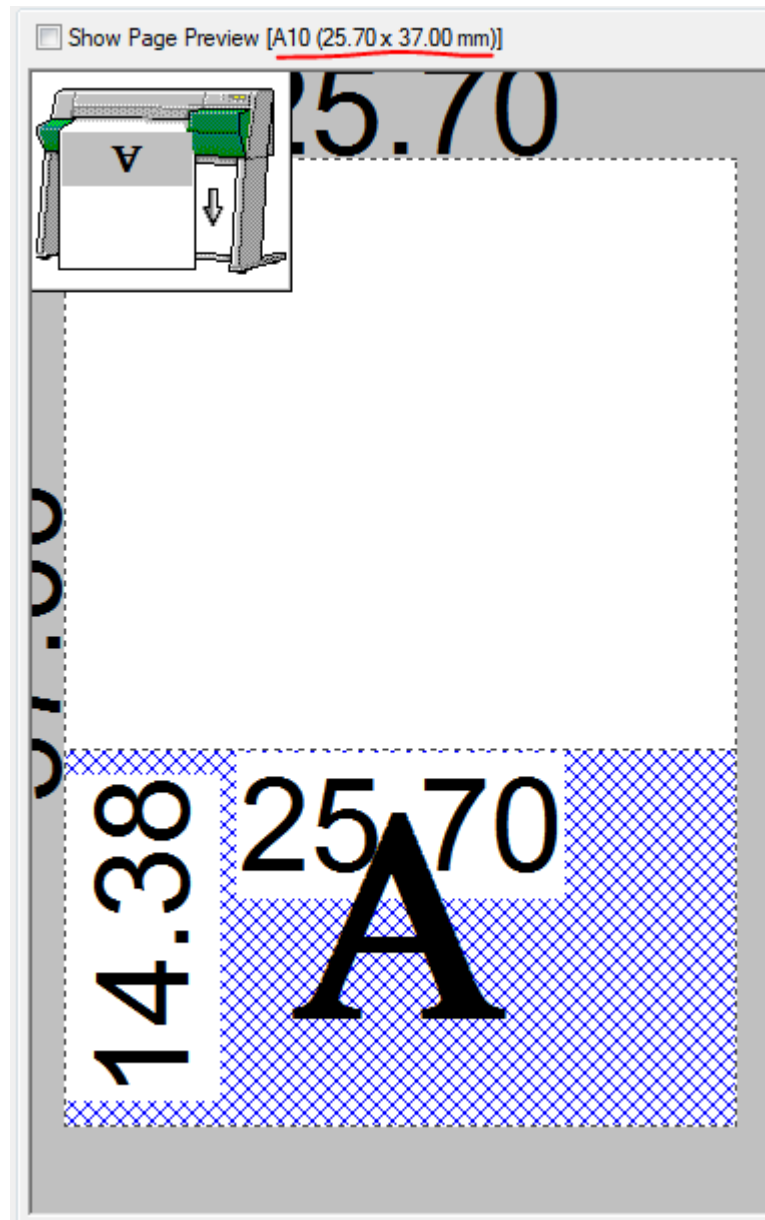

## Fixing IFC Import

Import of faces and objects for a specific file has been fixed.

Import of a specific IFC4 file, which lost some objects: walls with window openings, has been fixed.

## Work with Layers

The isolate layer (LAYISO) command now saves its settings between work sessions.

The work of  **Match layer** (LAYMCH) command has been restored.

The effect of the **Apply layer filter to layer toolbar** from the **Layers** dialog on the standard layer filter **All non-Xref Layers** has been restored.

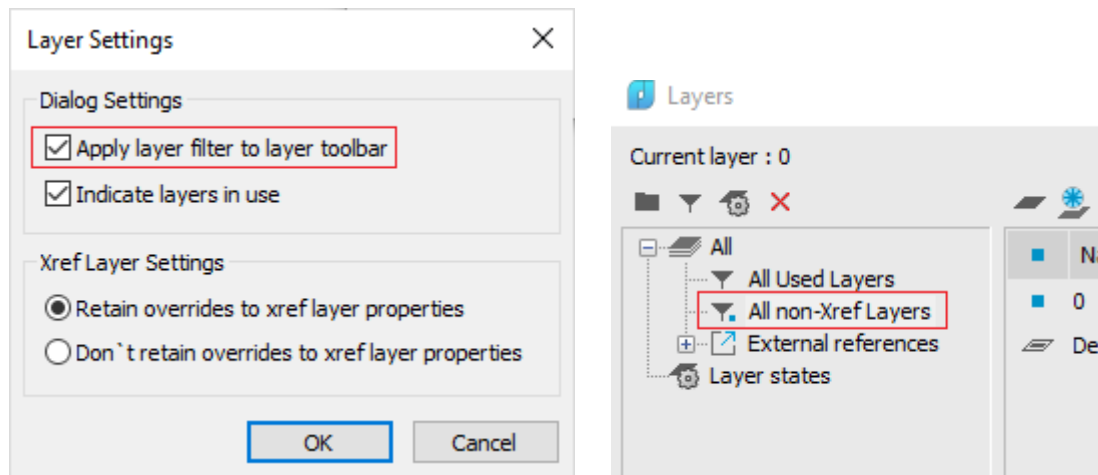

The selection of an option value by symbol in the **Properties** bar and in the Ribbon has been restored.  
Example:

- Create several layers. For example: **Blocks**, **Windows** and **Doors**;
- In the **Properties** bar or in the Ribbon, open the drop-down list of layers and press the letter **d** on the keyboard;
- nanoCAD will highlight the **Doors** layer.

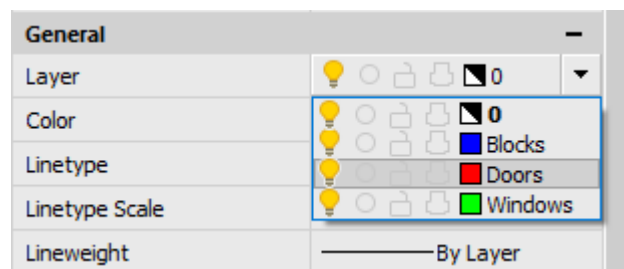

## Fixing Bugs that Caused the Program Closedown

A number of errors when importing point clouds (NPC\_IMPORT) from the RCP format, including those that caused the program to hang and crash when the file size is more than 2 GB have been fixed. Also RCS file checks have been added and the path generation function has been fixed.

The bug that in a particular case caused the program to stop working when trying to select a DWG table in a user file has been fixed.

The bug that in a particular case caused the program to stop working when trying to import a custom IFC file has been fixed.

The program crash when importing a custom PDF, or after pasting it as a background has been fixed.

## Crashes and Errors on Certain Files

An object associativity bug that led to an error message when changing dimension objects in a particular file.

A crash in the Construction and Mechanica modules when opening files has been fixed. The problem was in processing of proxy objects.

A crash when opening a file (problems with tessellation of polygonal faces) has been fixed.

A crash when opening a file (problems inside solid objects) has been fixed.

A crash when opening (problems with 3D) has been fixed.

## Other Corrections

The bug in the QSELECT dialog due to which multiline texts were erroneously taken into account in the text column has been fixed.

The bug due to which the settings of layer properties of design objects for new documents “flew off” has been fixed.

The bug due to which when switching from a layout to a model, the measurement scale of dimensions changes has been fixed.

. The bug where nanoCAD installed under an administrator account would not run on other accounts has been fixed

The mechanism for updating XBim libraries when updating nanoCAD has been corrected.

The bug when, while creating startup configurations for loadable vertical applications, the encoding of Cyrillic paths in the #include lines was lost in the configuration master file, has been fixed.

Also the bug where the correct include link from the configuration file was not loaded if its encoding was saved in UTF8 format has been fixed.

A crash when calculating and displaying the length of some splines with a huge number of vertices, programmatically generated by the vertical application has been fixed. Also, a crash when trying to get the “Middle” anchor point for such splines and their “disappearance” when simplifying has been fixed. As a result of corrections, the mechanism for calculating the length of the spline has been redesigned.

The case when, after creating layouts according to a template on user files, and using the **Audit** (AUDIT) command, layouts disappeared in the document, and nanoCAD ended its work, has been fixed.

The bug due to which the viewport was not deleted in the model space of a custom file has been fixed.

The bug where the **Convert to 2D** (FLATTEN) command destroyed such SPDS proxy objects as **Wall** and **Section**, has been fixed

The bug due to which, while creating a polyline offset the width of its segments and the global width were not copied, has been fixed.

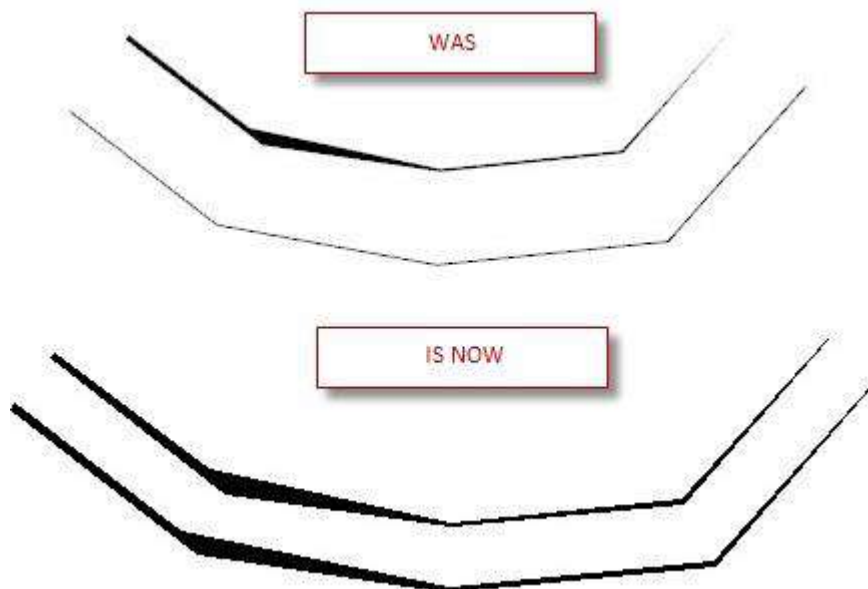

The error of copying a point cloud from one open document to another using COPY-PASTE commands has been fixed. The result was an incorrect cloud.

The bug due to which the LIST command for displaying data about the properties of selected objects incorrectly calculated the object area in some units (in particular, feet and inches) has been fixed.

The bug where the internal plotter settings dialog did not take into account the paper format previously selected in the plot settings dialog (opening with ISO A6 format displayed) has been fixed.

An erroneous behavior of the **Open file location** command of the context menu of the document tab, which resulted in opening the folder of the last opened file, has been fixed.



The bug due to which, in the dialogs for inserting xrefs and inserting blocks, objects on the preview were displayed without taking UCS into account.

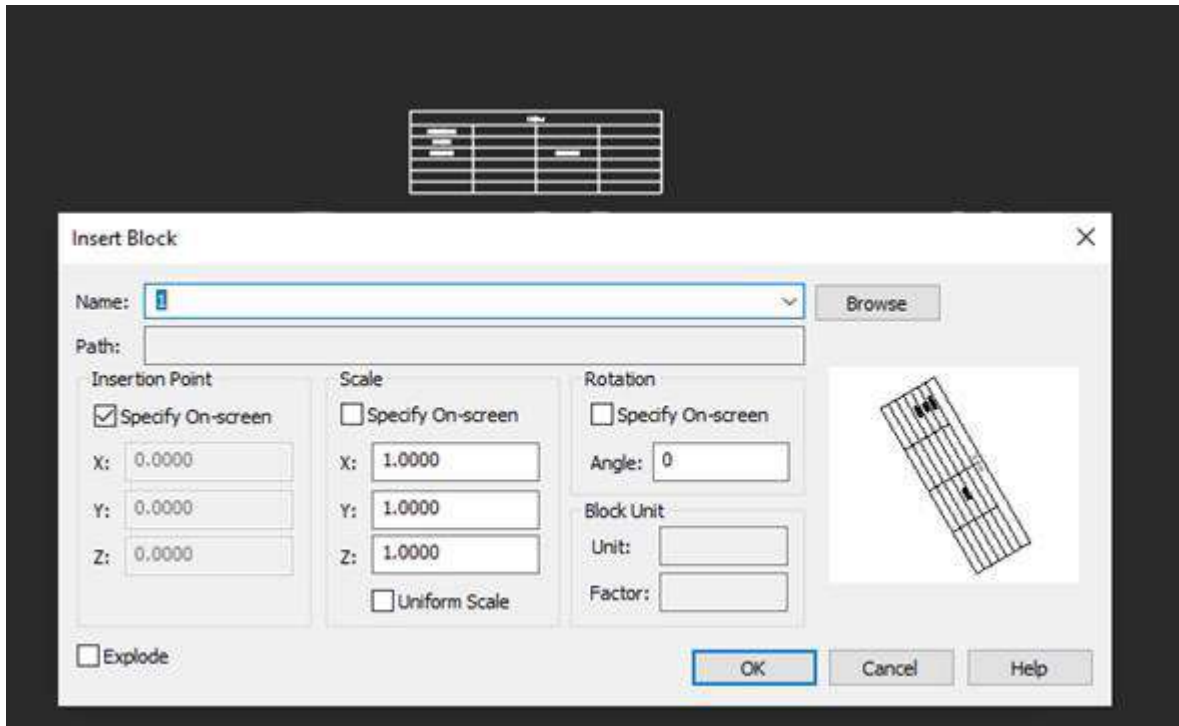

It is forbidden to insert an external reference whose name matches the name of the file into which it is inserted. The following prompt appears on the command line: "Error: Possible circular reference to current drawing."

The error of inserting a nanoCAD drawing as an OLE object into other software products (for example, in Word or Excel) if the nanoCAD window was in a minimized state has been fixed.

Special paste of an object from nanoCAD into a third-party application as a Windows metafile (EMF) has been fixed:

1. Copy the object from the nanoCAD drawing to the clipboard (CTRL+C).
2. Paste into Word via **Spec Paste** (CTRL+ALT+V) and select the **Windows Metafile (EMF)** type.

The bug due to which, when copying objects the position of the dimension line of the diameter dimension was changed, and one of the arrows of the dimension lines was also lost, has been fixed.

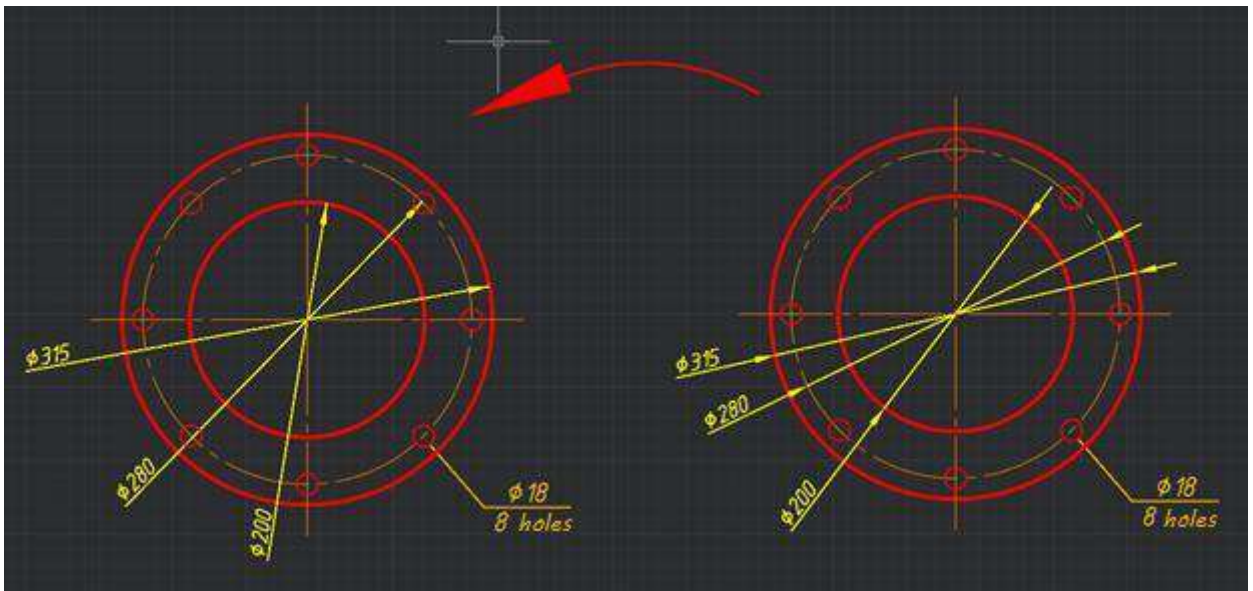

The error in constructing a radius dimension when creating a connection, when only an arrow was displayed without a dimension line.

The delay in changing the font and style in the drop-down list of the multiline text editor after the undo operation (UNDO) has been fixed:

- When editing multiline text, select the text and select a different font in the **Font** field (for example, Arial) or set a different style in the **Style** field.
- Undo the last action (UNDO).

The text shape will change, but the name of the font (or style) in the field on the panel will remain the same.

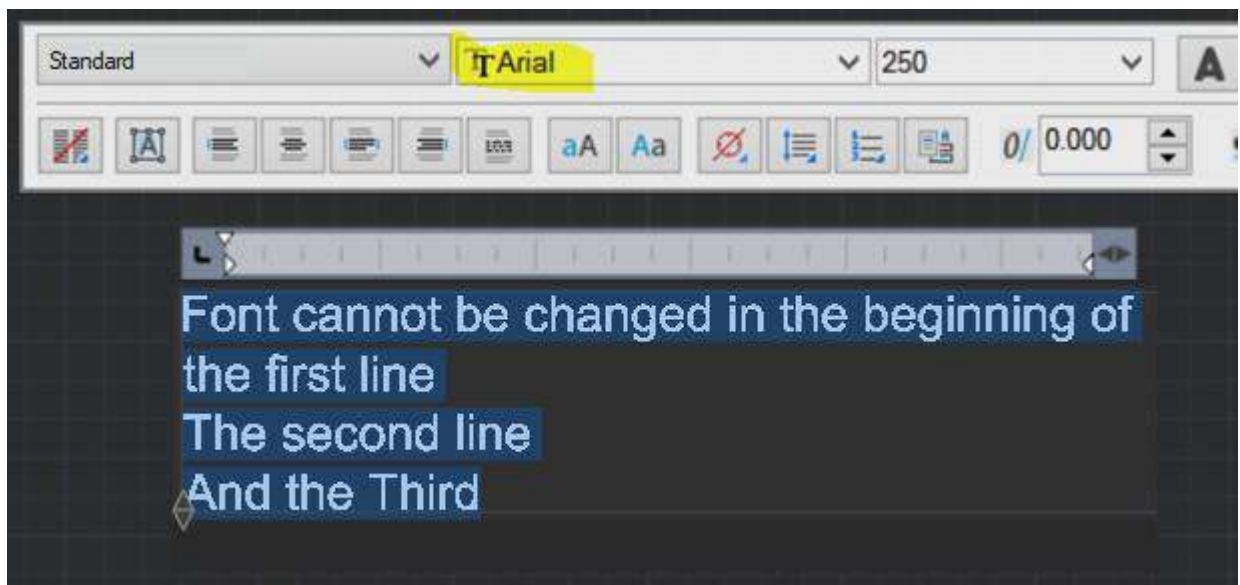

The multiline text bug due to which, in a particular case, the TTF font was not changed has been fixed.

The bug where pressing **Enter** at the end of the last line of a multiline text while editing it caused the MTEDIT command to exit instead of creating another line.

The bug in the single line text creation command has been fixed. When trying to change the location of the next text object by clicking in the drawing field, the command crashed.

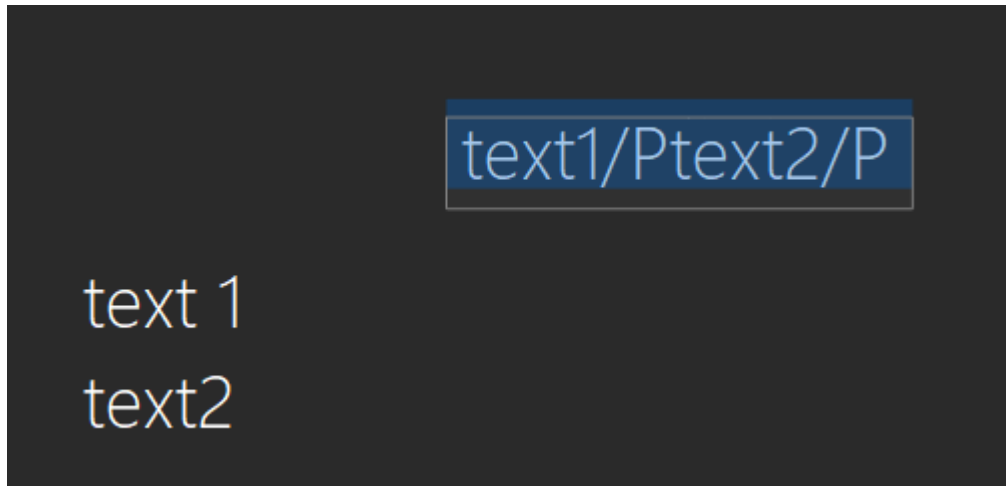

The error in the display order of raster images after aligning the underlying raster with the ALIGN command has been fixed. After applying the command to a raster image, it was displayed above other images, until the viewport was updated (REGEN).

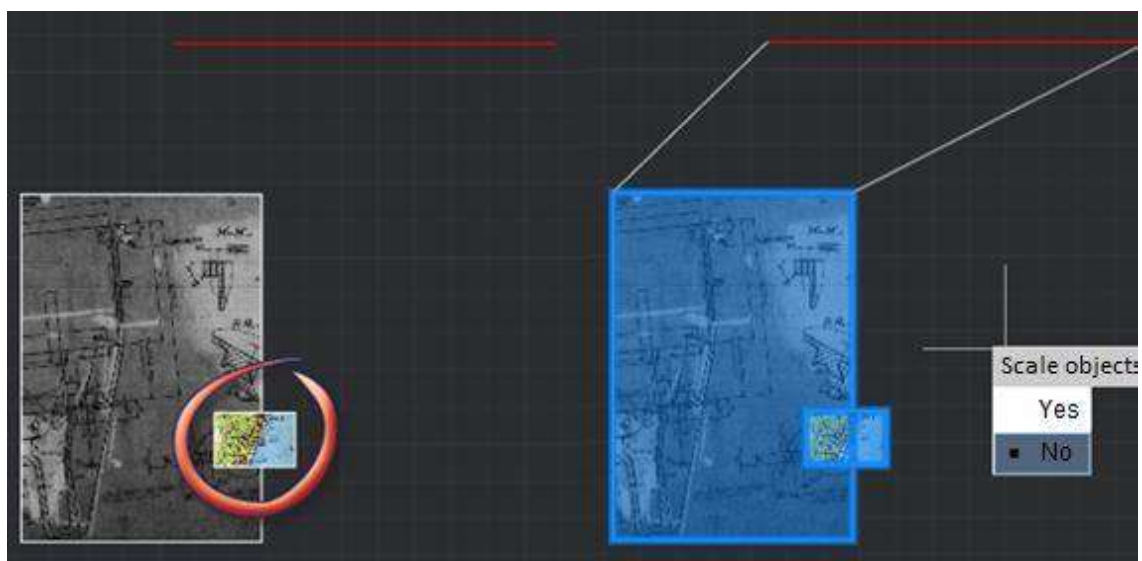

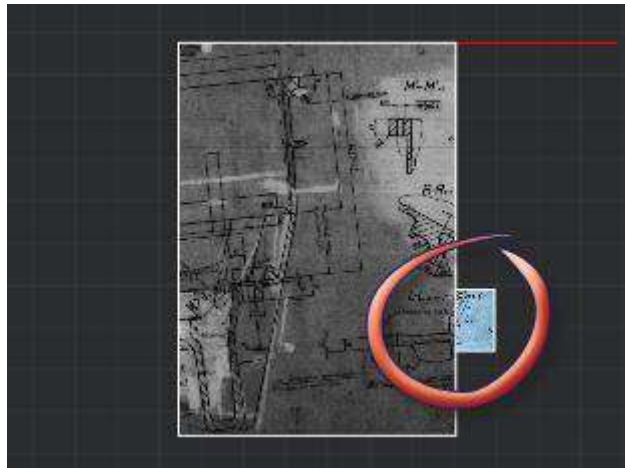

The bug, as a result of which, in some drawings, the document purge command from the command line (-PURGE) with the **Full** option led to the program crash (the Standard table style was deleted) has been fixed.

A defect in changing the UCS in a user file has been fixed.

The non-working button and the menu item of the command to insert the material were blocked in the table editor and the notebook of nanoCAD, since it is possible to insert a material only with the active Construction and Mechanica modules.

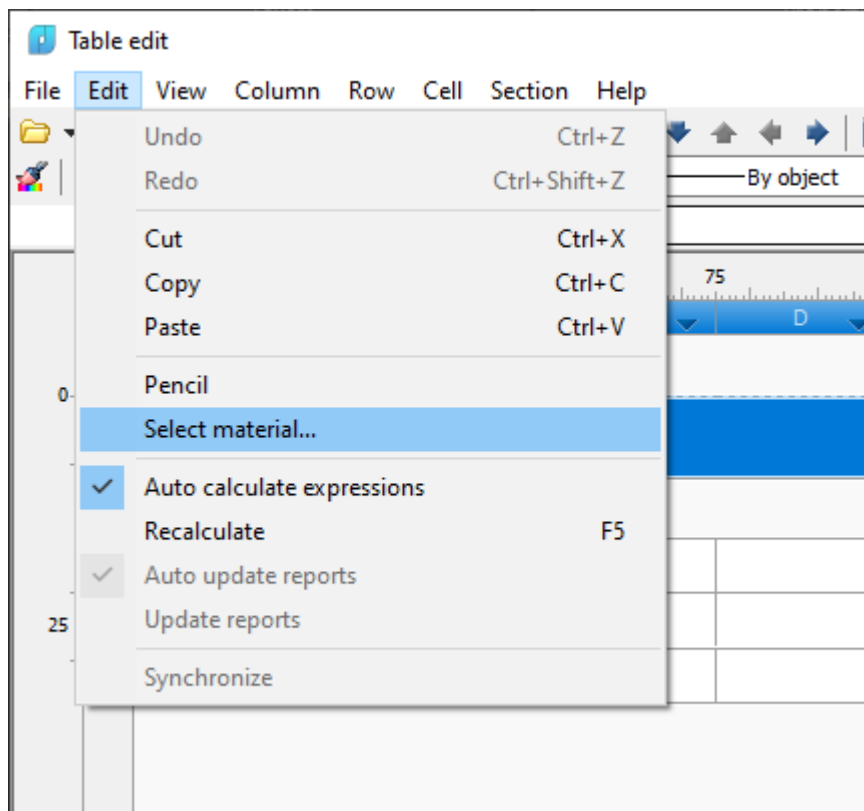

Now, when selecting objects, the state of the PICKFIRST variable is taken into account. The description of the variable in the System Variables Monitor has also been edited.

When inserting a nanoCAD drawing file into another program (for example, Word) as an OLE-object, the error message "Unable to create an object. Make sure this application is registered in the system" appeared. This happened when nanoCAD was minimized. This error has been fixed.

Two bugs have been fixed, which appeared after the document window was made floating:

1. Open two documents.
2. Make one of the documents floating (**Float window** item of the document tab context menu).
3. Create a new block in the floating document.
4. Close the second document.
5. When calling the block editing (BEDIT) or reference editing (REFEDIT) commands in a floating document, the tabs of these editors did not appear in the ribbon.

1. In a document with a block, run commands for editing a block or an external reference (BEDIT or REFEDIT);
2. Undock the document window;
3. Close the editor in the floating window with the appropriate command on the editor bar.
4. In the main window, the editor tab remains hanging, and it is impossible to close it.

Syntax errors in the configuration (CFG) files leading to errors have been fixed.

The interface customization dialog (**Customize User Interface** (INTERFACE command)) became more resistant to syntax errors in configuration files. For example, the dialog would break if a FlyOutStart=0 was encountered in the CFG file without a preceding FlyOutStart=1. In particular, the keyboard shortcuts section turned out to be empty.

If an attempt was made to create a new key combination with an empty list of keyboard shortcuts, then the program crashed.

The icons and design of the Welcome window have been optimized to work with 4K monitors. Tooltips to window elements have been added.

The **COGOPoint Styles** section in the **Drawing Explorer** bar has been renamed to **COGOPoints**. The **User-Defined Property Classification** has been added to the section.

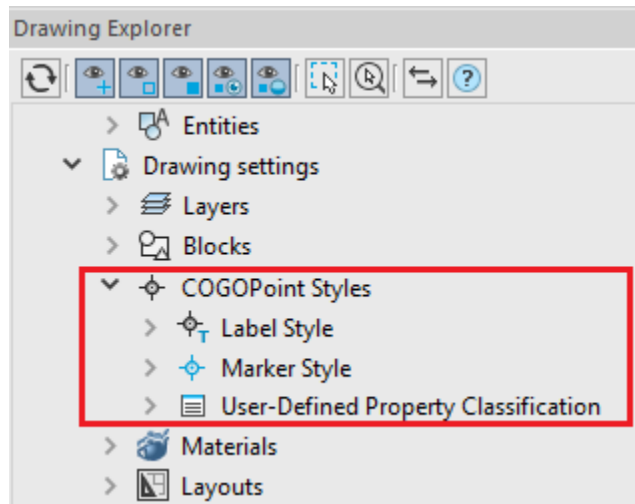

2D polyline snaps were displayed in the wrong place. The error could be stably reproduced on a 2D polyline obtained by creating an ellipse with PELLIPSE = 1.

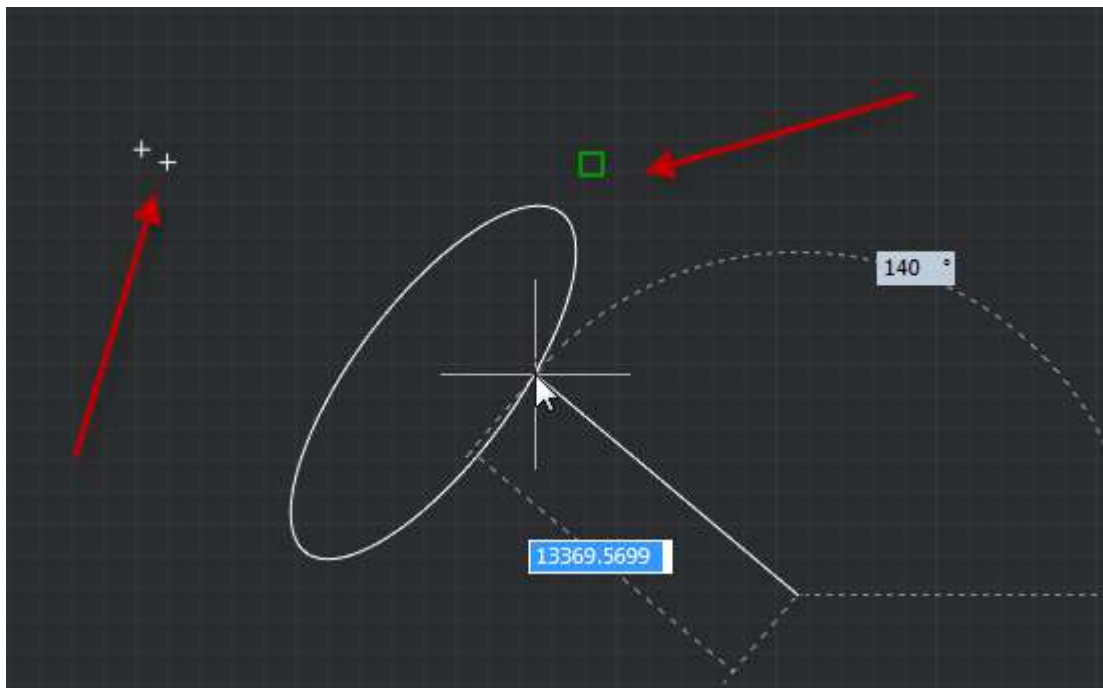

When opening the **Find and Replace** dialog box (Ctrl+F), the cursor is immediately placed in the **Find what** field. No extra click needed to get to this dialog like before.

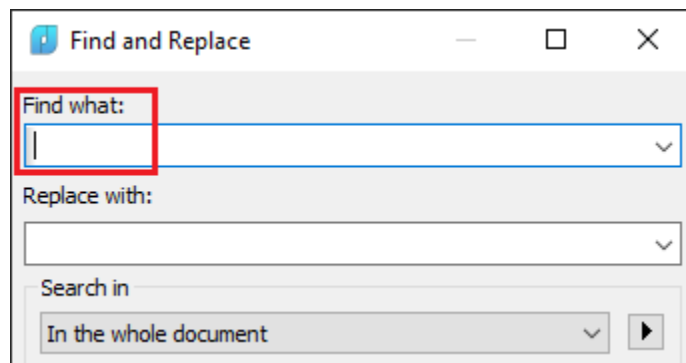

A lisp file interpretation error has been fixed: setting a custom viewport scale resulted in an error.

In NanoCAD the processing of multiple imposed and inserted circular references. Where, for example, some DWG files can have superimposed links to other DWGs in which they themselves are inserted as a reference.

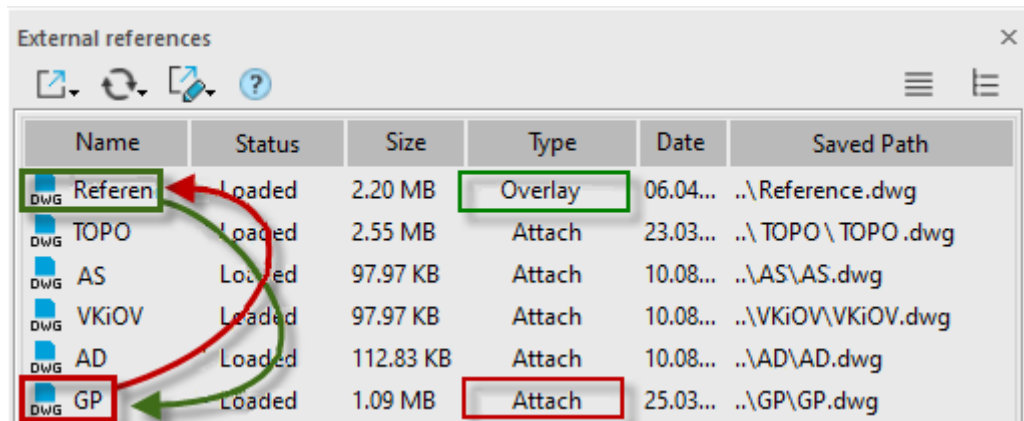

In previous versions of nanoCAD, it was impossible to create or edit an existing system of cyclic references - once such a reference was deleted, it either could not be reconnected (there was an error **Possible circular reference to current drawing**), or it was necessary to break the links for each file.

The bug when, while editing an existing text in a DWG table cell (DTABLE command), the text being entered was simultaneously displayed above the previously entered text, has been fixed.

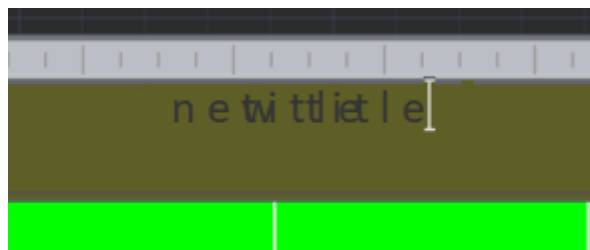

The bug when while editing an existing text in a DWG table cell (DTABLE command) it was impossible to delete this text - after editing the cell, the text was displayed again.

The deletion of the original object when creating a cloud by object has been restored:

1. Create a rectangle.
2. Run the **Revision cloud** (REVLOUD) command, select the **Object** command option, specify a rectangle.

The cloud will be created and the rectangle will be deleted.

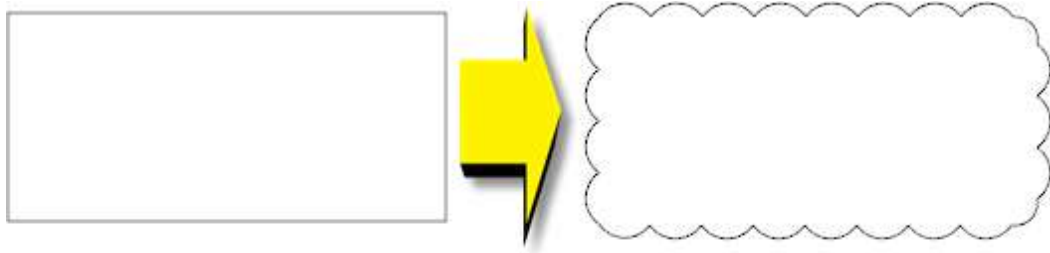

A situation with the program crash when inserting an associative array added earlier to the **Tool Palettes Manager** bar:

1. Add any associative array to the **Tool Palettes Manager** bar by dragging. It will get a name like **\*U2**.
2. When trying to insert an array into another drawing, the program crashed.

Now it is prohibited to add an anonymous block insertions to the **Tool Palettes Manager** bar (which happens in the case of an associative array)

The crash when enabling and disabling a layer with a dot in its name in the **Properties** bar has been fixed.

1. Create a layer in a new file. The title should contain a dot at the end. For example: "Layer1."
2. in the **Properties** bar, turn off visibility of this layer, or freeze, or block, or turn on/off plotting. Abnormal program termination.

A critical API error related to deleting a drawing object from a parallel stream when a box selection command is active has been fixed.

The nanoCAD crash when updating the cache of paper formats when accessed through a script has been fixed.

## POINT CLOUDS

### Work with Databases

If there is a connection to a database, the **Importing Cloud Data from a Database** (DB\_TO\_NPC) command loads a point cloud from the specified database into the drawing. If there is no connection to the database, you will be prompted to configure it.

When exporting a point cloud from a database, it is possible to display a point cloud preview in the import dialog, and configure the import parameters.



If there is a connection to a database, the **Exporting Cloud Data to a Database** (NPC\_TO\_DB) command uploads a point cloud from the drawing to the specified database. If there is no connection to the database, you will be prompted to configure it.

The **Database Configuration** (NPC\_DB\_CONFIG) command connects to databases with point clouds.

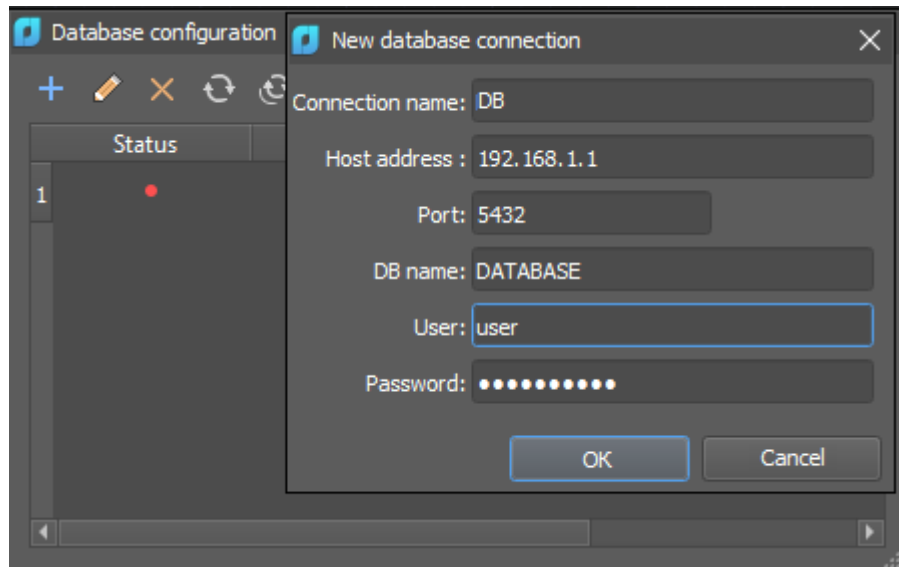

## Managing the Display of Features in a Cloud

The commands to manage the display of features apply to point clouds in which geometric features have been previously found: pipelines, pipeline elements, planes, and plane elements.

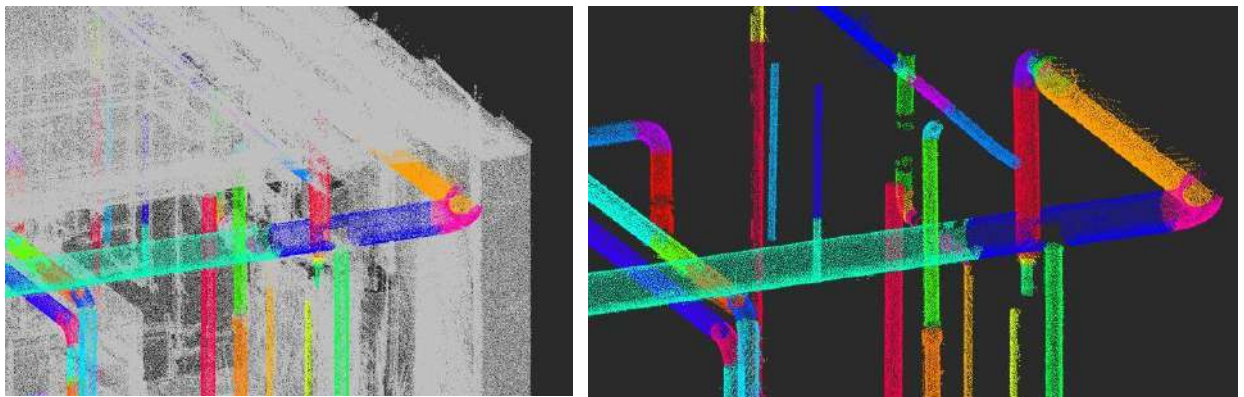

- **Hide Feature** (NPC\_HIDE\_FEATURE). The command hides the feature specified in the point cloud (pipeline element, plane). Works with point clouds in which geometric features have previously been recognized.
- **Hide All Features** (NPC\_HIDE\_ALL\_FEATURES). The command hides all features found in the point cloud (pipeline elements, planes). Works with point clouds in which geometric features have previously been recognized. Points where features have not been identified remain visible.
- **Isolate Feature** (NPC\_ISOLATE\_FEATURE). The command isolates the feature specified in the point cloud (pipeline element, plane). All other cloud points are hidden. Works with point clouds in which geometric features have previously been recognized.

- **Isolate All features** (NPC\_ISOLATE\_ALL\_FEATURES). The command isolates all features found in the point cloud (pipeline elements, planes). Works with point clouds in which geometric features have previously been recognized. Points where features have not been identified are hidden.
- **Feature Isolation Reset** (NPC\_UNISOLATE\_ALL\_FEATURES). The command turns on the display of all isolated features, as well as points where features have not been identified.
- **Show All Features** (NPC\_SHOW\_ALL\_FEATURES). The command displays all features, while the points where features have not been identified remain invisible (if they were previously hidden).

## Getting Pipe Parameters

The **Determining the Radius** (\_NPC\_RADIUS) command copies the radius of pipes and cylinders found in the point cloud to the command line.

```
_NPC_RADIUS - Determining the Radius  
Select point cloud vertex:  
Command: 0.0679971
```

The **Determining the Diameter** (\_NPC\_DIAMETER) command copies the diameter of pipes and cylinders found in the point cloud to the command line.

```
_NPC_DIAMETER - Determining the Diameter  
Select point cloud vertex:  
Command: 0.135994
```

## Import of Point Clouds

The dialog box of the **Import point cloud** (NPC\_IMPORT) command has been completely updated, new functionality has been added.

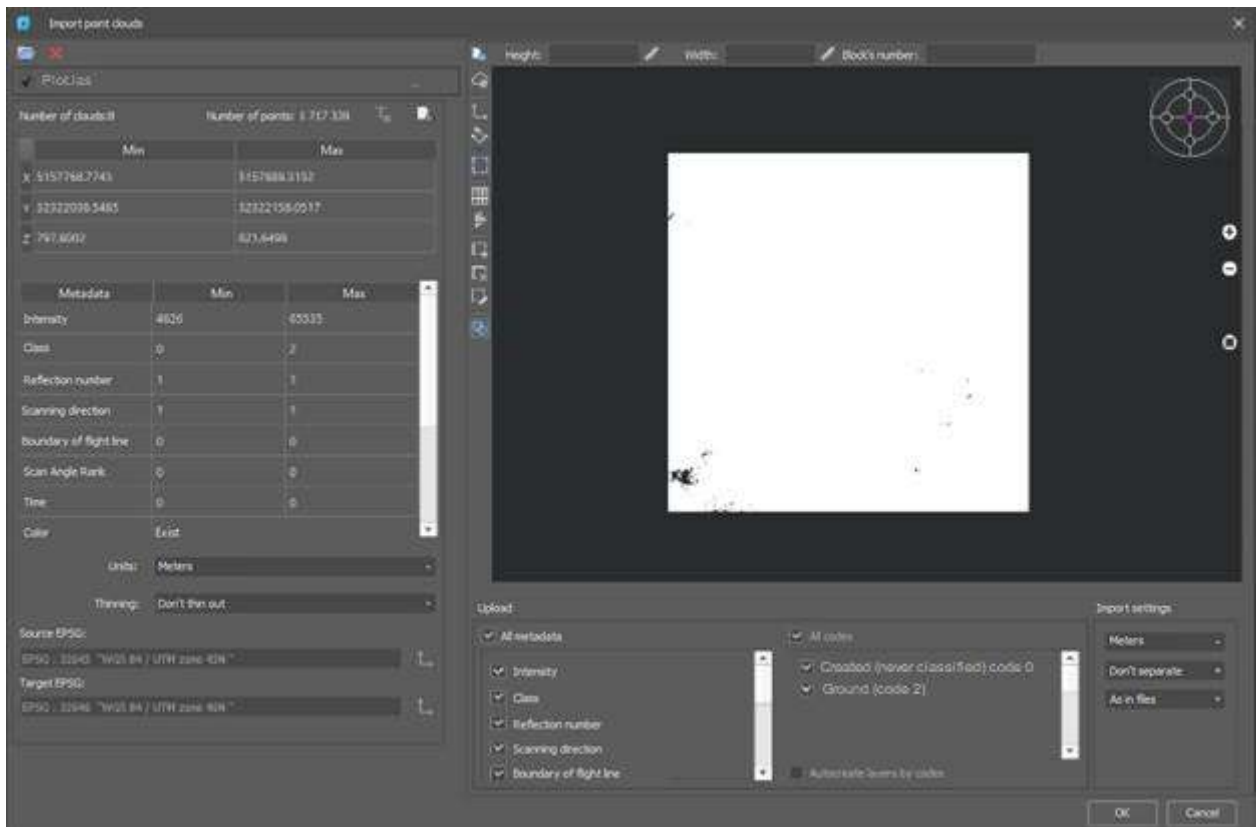

- A possibility of simultaneous import of several files has appeared;
- Viewing information about the file has been added;
- Now it is possible to transform a cloud by EPSG codes, if the point cloud has a coordinate system described by the EPSG code;
- A possibility to set any cloud coordinate system from the list of EPSG codes, even if initially it was not linked to the cloud has been added;
- The point cloud preview window has acquired convenient tools for navigating the cloud, including in 3D viewing mode;
- The function of splitting a cloud into blocks, both along the mesh and along the flight line, has been implemented. In this case, the cloud is not loaded immediately into the drawing. A set of dwg files is created in the folder with the point cloud, each of which contains a block – a fragment of the cloud obtained by splitting the source file in accordance with the specified parameters. The function is convenient to use to automate import, the resulting fragments can be loaded into the drawing separately, significantly reducing the amount of memory used.

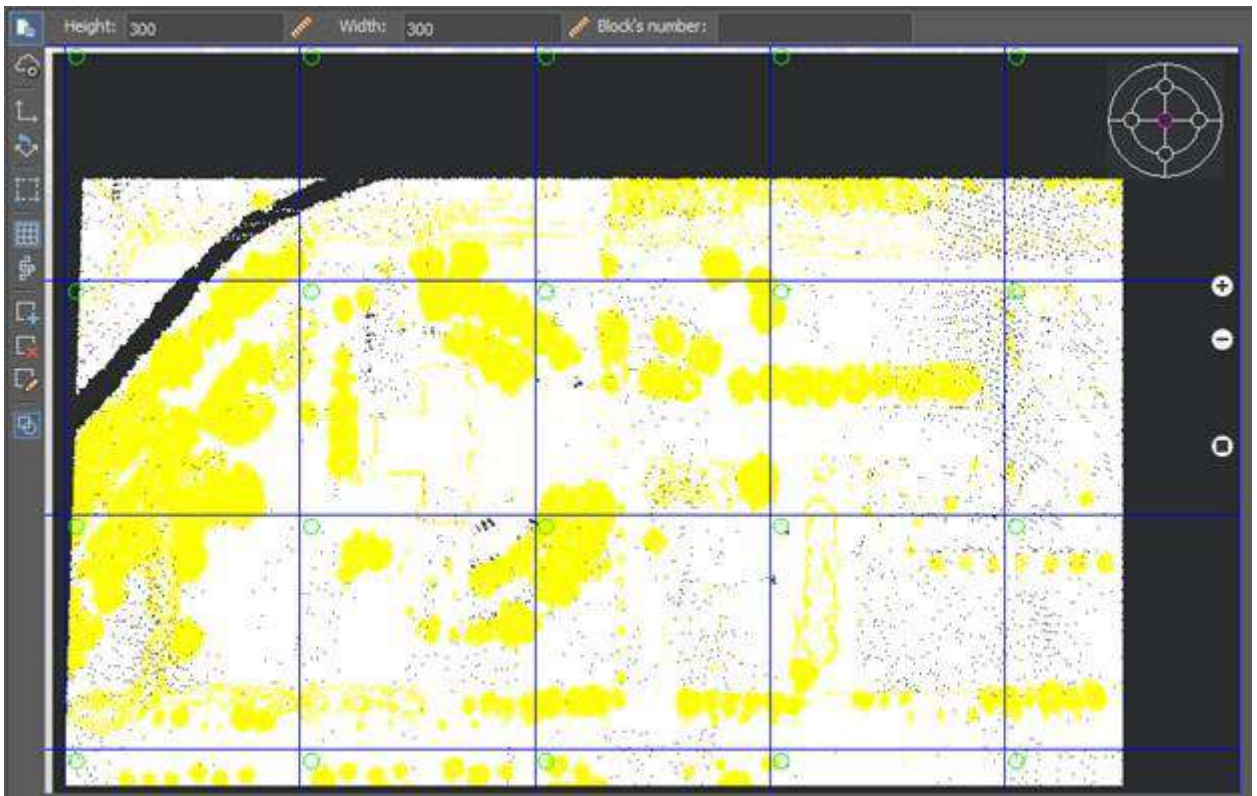

## Differentiating Clip Commands

Point cloud clipping commands are divided into inverting and non-inverting. Now, when clipping point clouds, you no longer need to select the option to clip points **Inside** or **Outside**. There are now separate commands for clipping inside and outside.

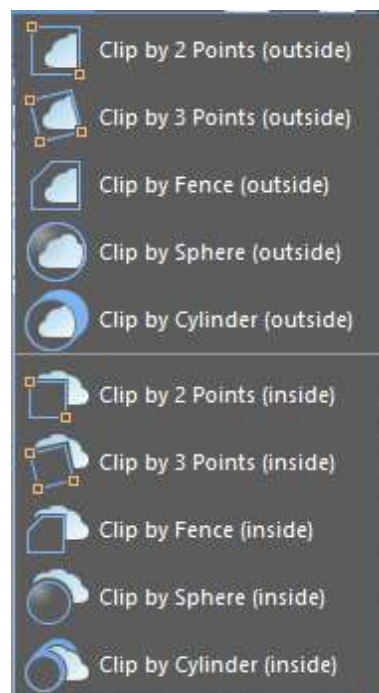

## Snap to Pipeline Turning Point

In the process of drawing, it has become possible to snap to the turning point of the pipeline.

## TOPOPLAN MODULE. NEW COMMANDS

\* The most up-to-date information on the new features of Topoplan Module is available [online](#).

### New Topoplan

The **New Topoplan** (NEW\_PLAN) command creates a new document with a pre-configured **nanoCAD\_EarthWork\_metric.dwt** template for the **Topoplan** module. The template is stored in the **Templates** folder. The following drawing units are set:

Drawing Units

Length  
Type: Decimal  
Precision: 0.0000

Angle  
Type: Deg/Min/Sec  
Precision: 0d  
Base Angle: East

Display in "input" format

Clockwise

Insertion scale  
Units to scale inserted content: Meters

Sample output:  
125.5000,254.0039,0.0000  
5.5000<45d,0.0000

Lighting  
Units for specifying the intensity of light: Generic

OK Cancel Help

### Recalculation of Coordinates

The **Coordinates Reprojection** (NG\_REPROJECTION) command recalculates the coordinates of topographic objects using EPSG codes.

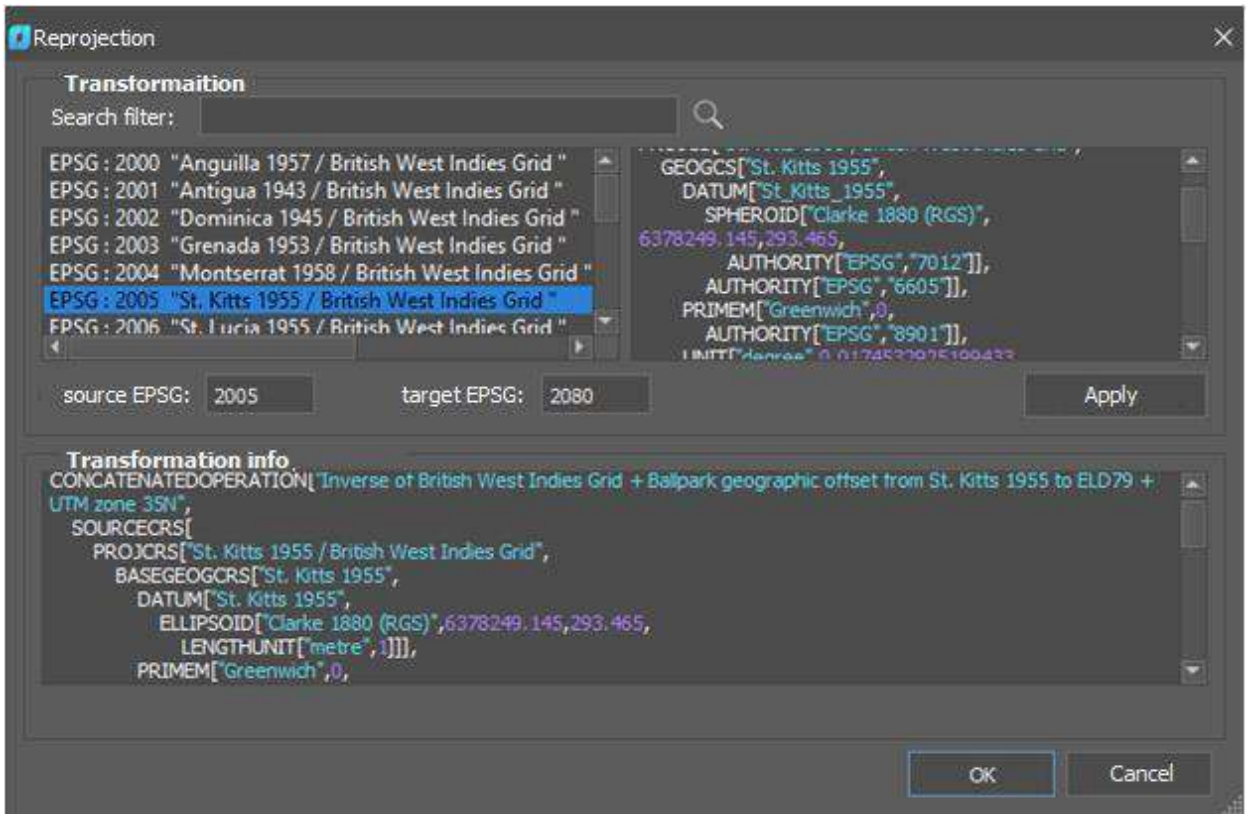

## Mesh Simplification

The **Simplify Mesh** (NG\_SIMPLIFY) command reduces the number of surface triangles.

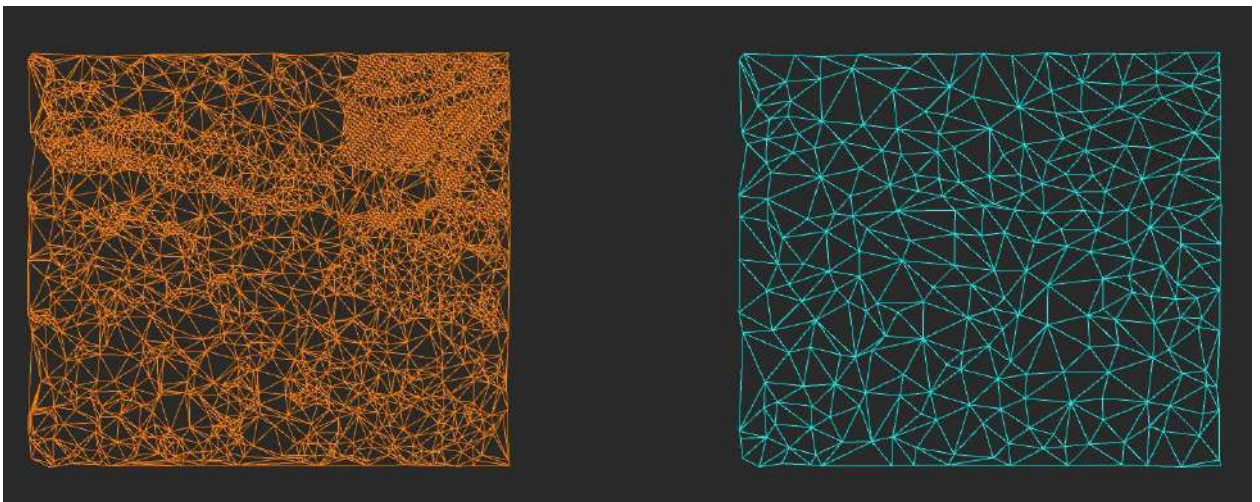

## 3D Slope

The **3D Slope** (NG\_3D\_SLOPE) command creates a 3D slope on a surface or on objects.

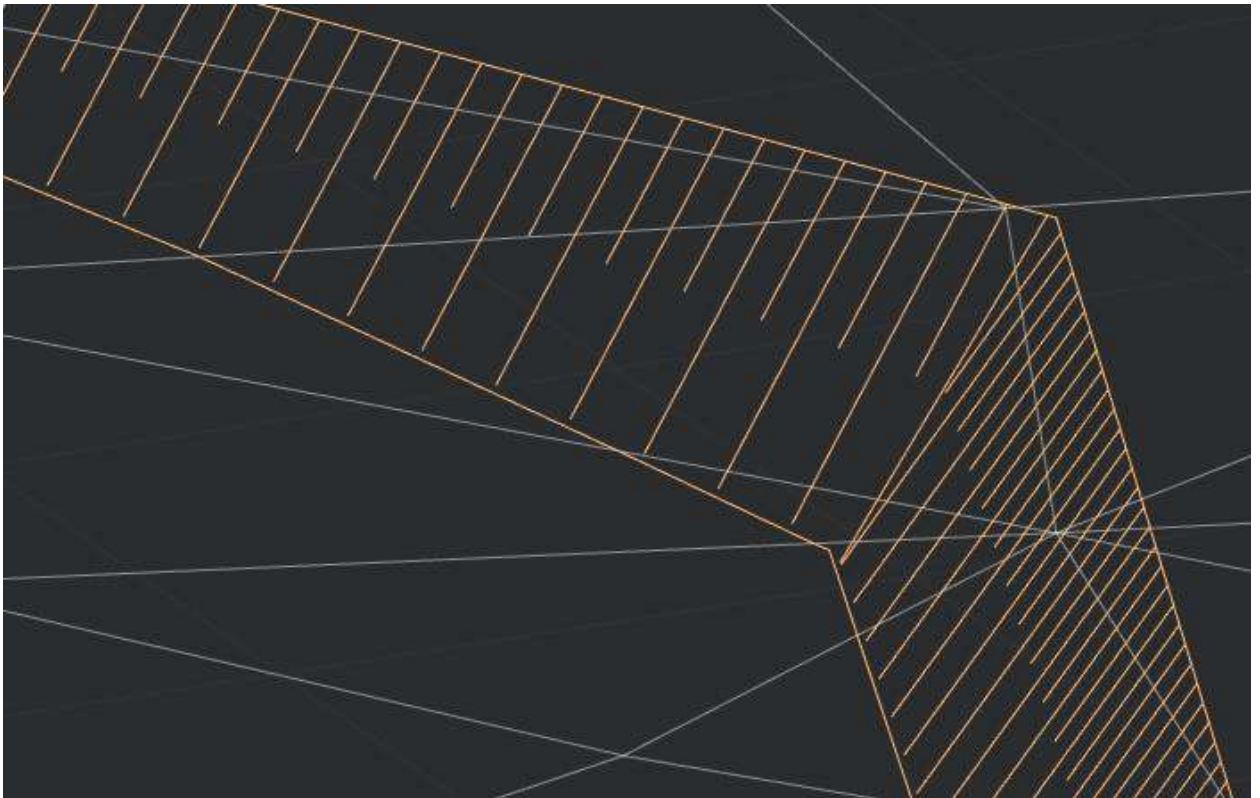

## 3D Polyline Offset

The **3D Polyline Offset** (3DPOLYOFFSET) command creates a similar polyline for a 3D polyline, with a specified distance from the original one (similar to the OFFSET command for two-dimensional objects).

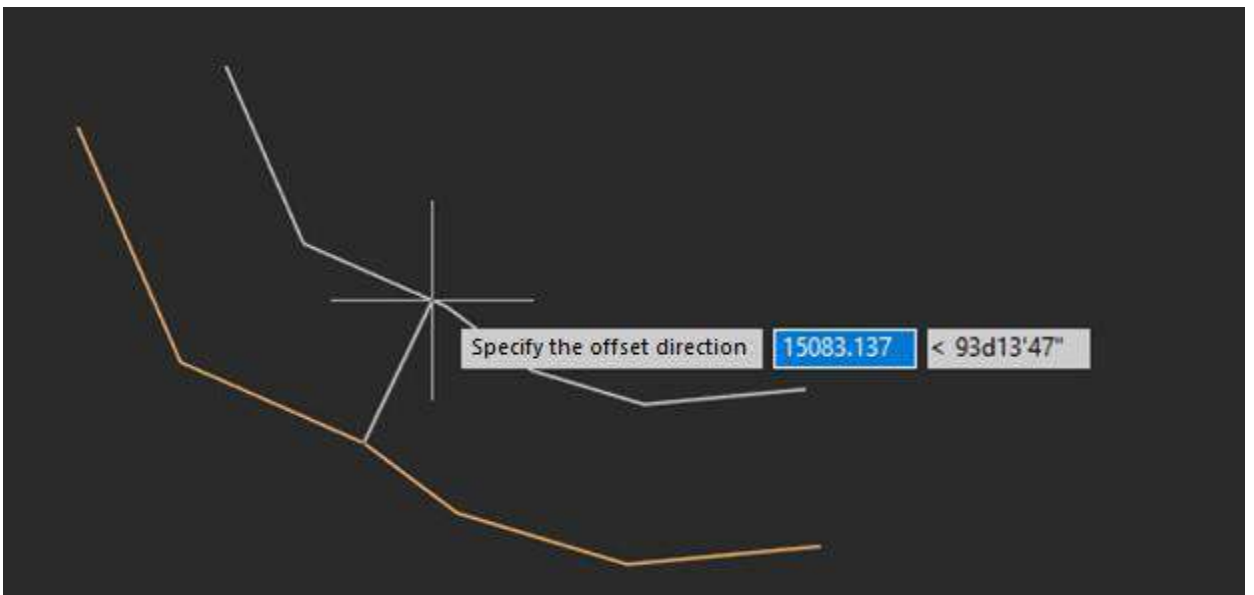

## Surface Difference

The **Height Difference** (NG\_HEIGHT\_DIFFERENCE) command creates a new surface as a result of subtracting one surface from another.

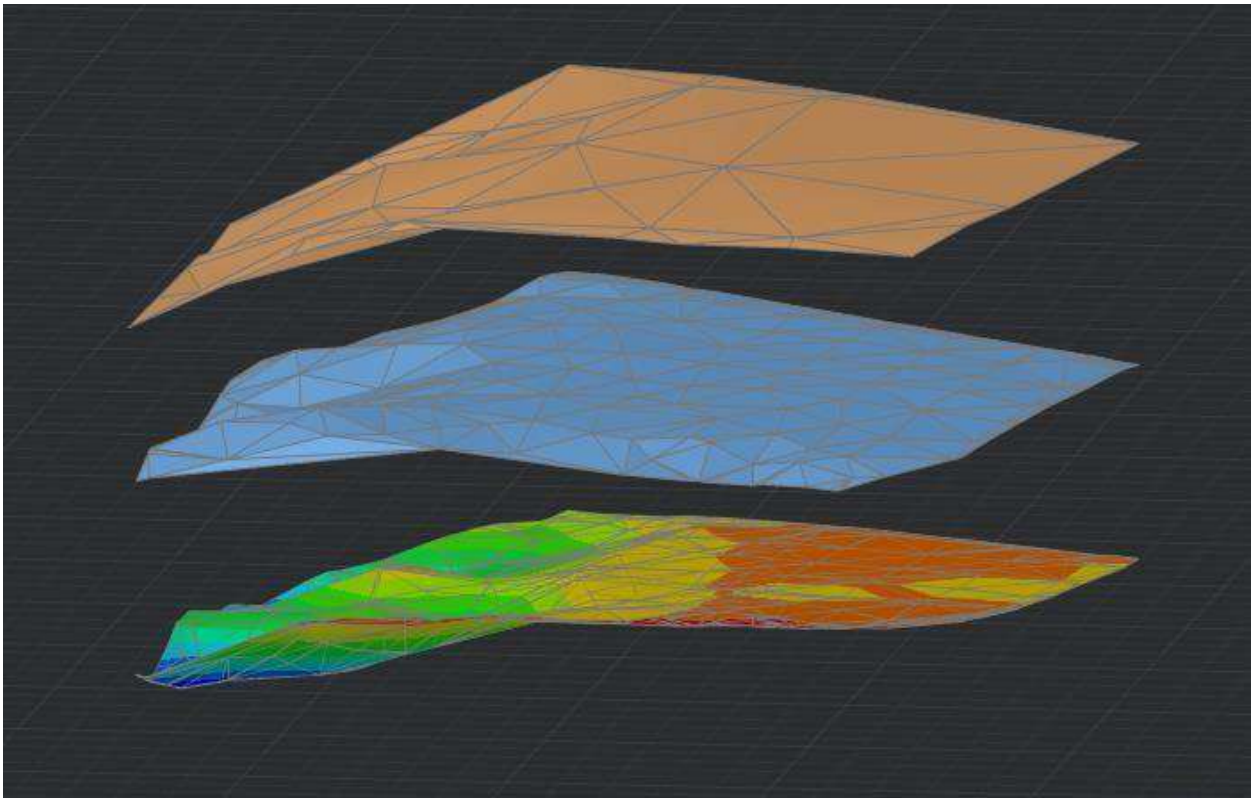

## Coloring Elevation Legend

The **Elevation legend** (NG\_PAINT\_ELEVATION\_LEGEND) command displays a legend in the form of a table for the selected mesh in the drawing with coloring by height.

Surface Elevation Ranges, Meters			
Number	Lower Limit	Upper Limit	Color
1	25.7632	27.7648	Blue
2	27.7648	29.7664	Light Blue
3	29.7664	31.768	Cyan
4	31.768	33.7696	Green
5	33.7696	35.7712	Light Green
6	35.7712	37.7728	Yellow-Green
7	37.7728	39.7744	Yellow
8	39.7744	41.776	Orange
9	41.776	43.7776	Red-Orange
10	43.7776	45.7792	Red



## Topographic Hatches

The **Fillshapes** (FILLSHAPES) command fills the contour with conventional symbols on a rectangular, checkerboard or arbitrary grid.

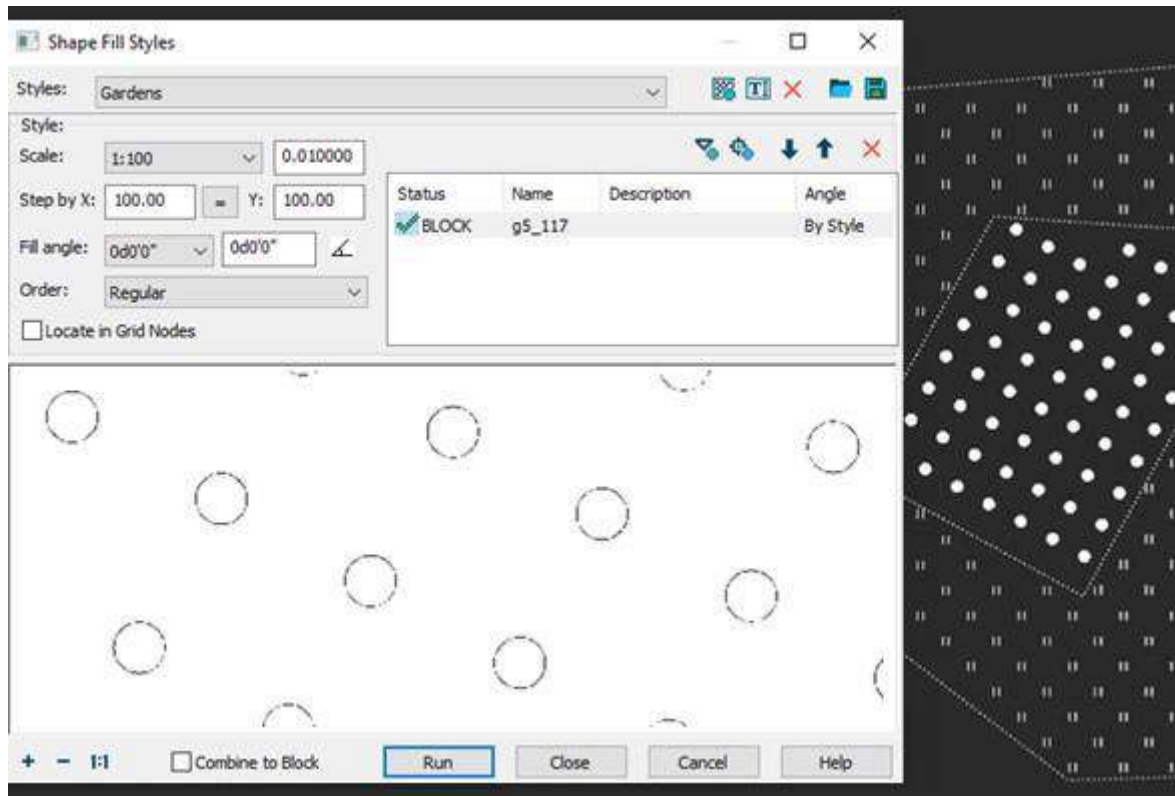

## Creating Geopoints Manually

The new command **Create Geopoints Manually** (NG\_CREATE\_POINTS)

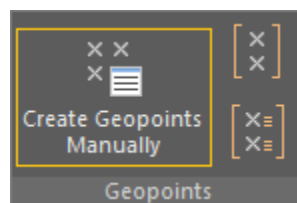

When creating, the location of the point in the drawing, description and elevation are specified.

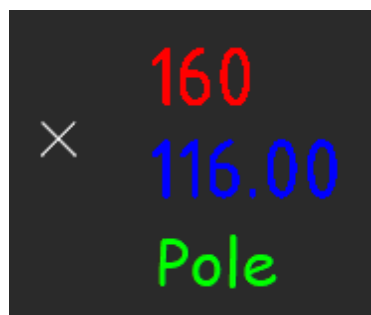

## Creating a Group of Geopoints Manually

The **Creating a Group of Geopoints Manually** command (C3D\_CREATE\_COGO\_POINT\_GROUP)

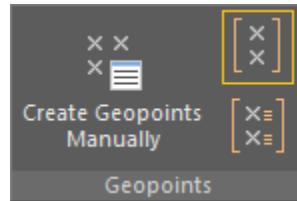

The command options are set in the **Properties** bar.

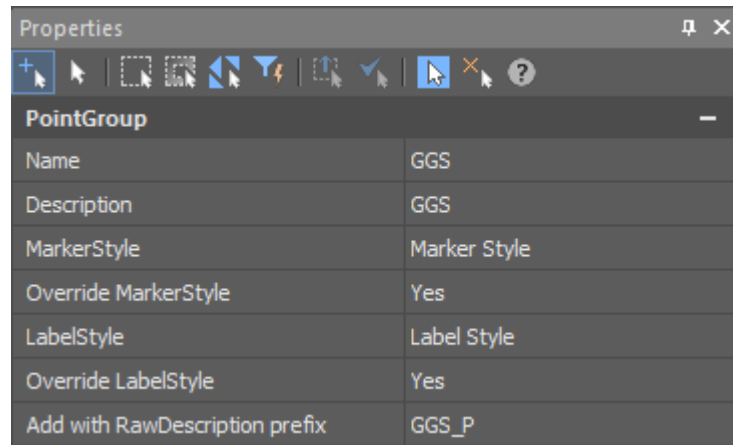

- **Group name;**
- **Description;**
- **Marker style** (of those existing in the drawing);
- **Override Marker Style;**
- **Label Style** (of those existing in the drawing);
- **Override Label Style;**
- **Add with Raw Description prefix.** The criterion for adding a point to the group. It allows you to add to the group only points with the specified raw description.

## Creating Groups of Geopoints by Original Description

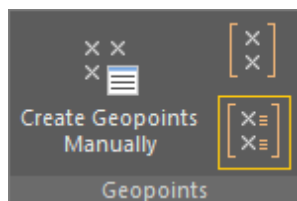

The **Create Groups of Geopoints by Original Description** (C3D\_CREATE\_COGO\_POINTS\_GROUPS\_BY\_RDESCR) – automatic creation of point group.

The command has no options.

All points with the same raw description are combined into one group. As many groups are created as there are different raw descriptions for geopoints in the drawing. The names of the created groups are the same as the raw descriptions.

## Editing, Renaming and Deleting a Group

Double clicking on the name of a group of geopoints in the **Drawing Explorer** now starts not the group renaming, but editing its parameters in the **Properties** bar.

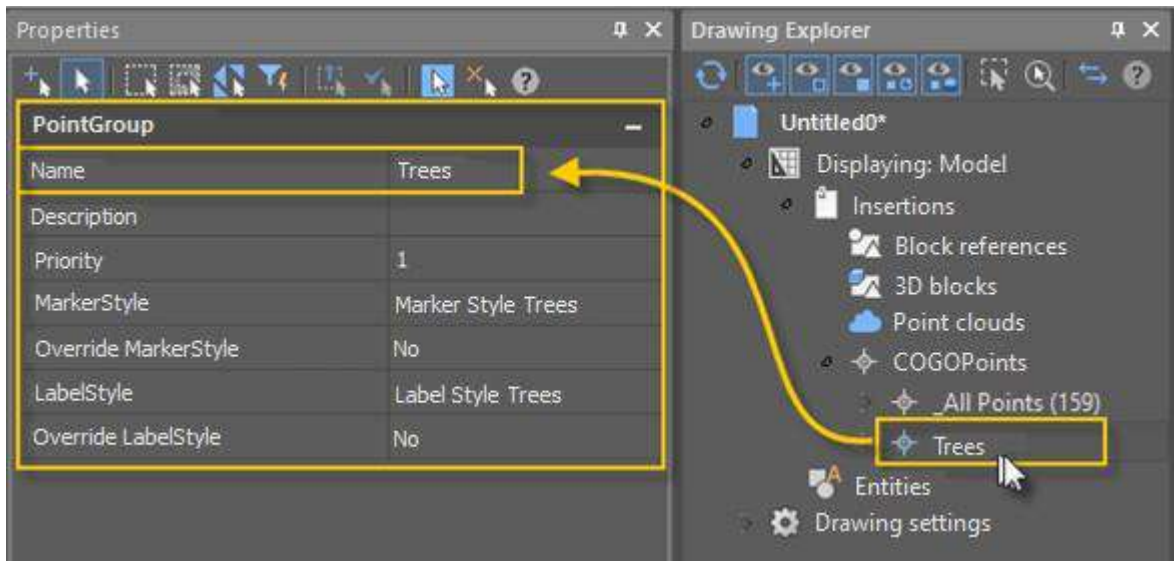

It has become possible to delete groups. It is performed from the **Drawing Explorer** by the **Delete** command of the context menu of an unnecessary group of geopoints. You can rename a named group of geopoints by selecting the **Rename** in the context menu of the named group.

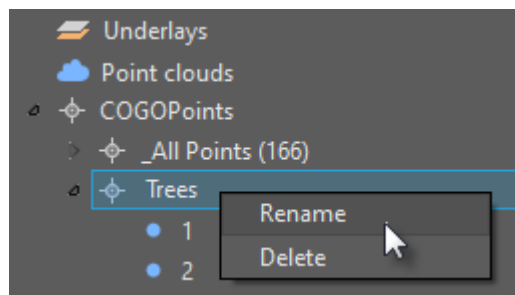

## New Grips of Geopoints

New grips have been added for a geopoint: label rotation and marker rotation. Moving them rotates the label and marker relative to the insertion point. The same parameters can be changed in the **Properties** bar:

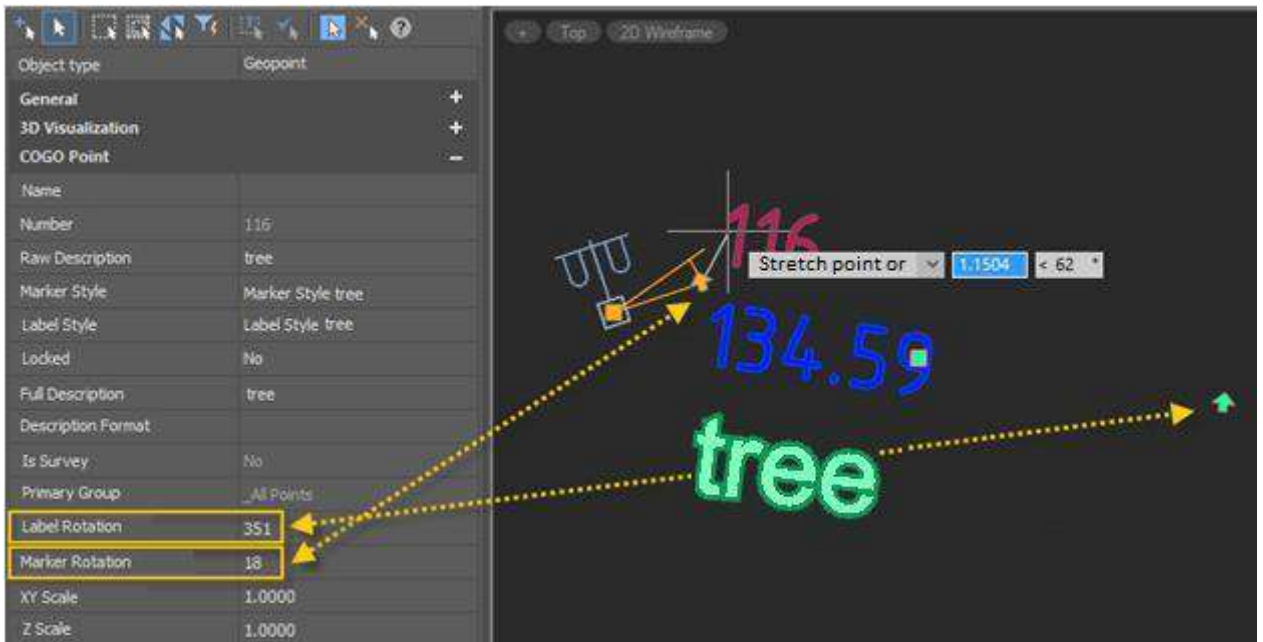

## Creating Geopoints by Points and Texts

The **Create geopoints by points and texts** (NG\_CREATE\_POINTS\_BY\_TXT) command creates geopoints by points (**circles, blocks**) and text objects (**texts, multiline texts**) found at a specified distance from them.

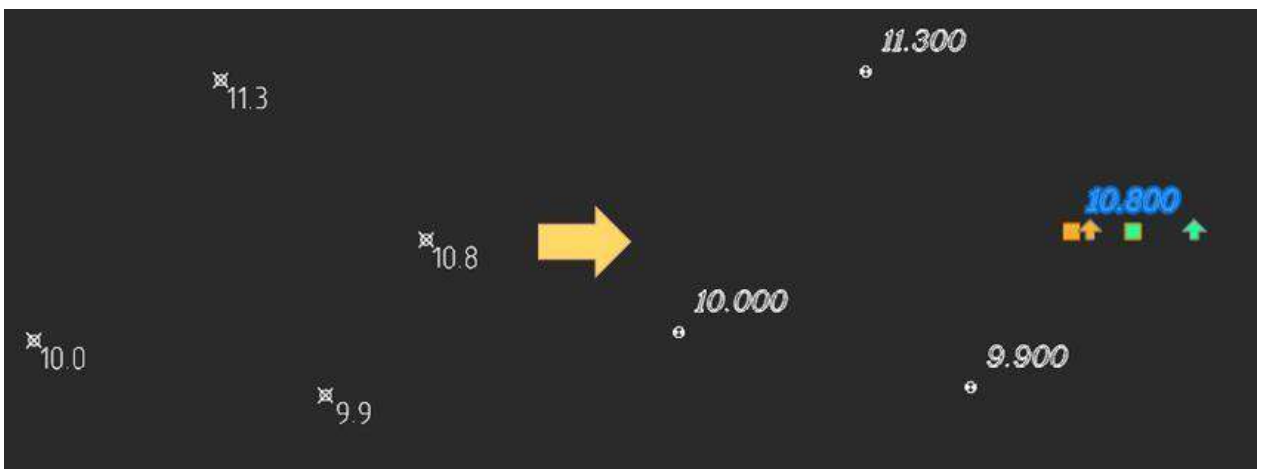

## Export Geopoints

The **Export geopoints** (NG\_EXPORT\_POINTS) command allows you to:

- export such objects as geopoints, blocks, simple points to txt, csv, sdr format, with the possibility to create labels in the drawing;
- save the label's rotation value or other user attributes when exporting to an external file;
- select encoding.

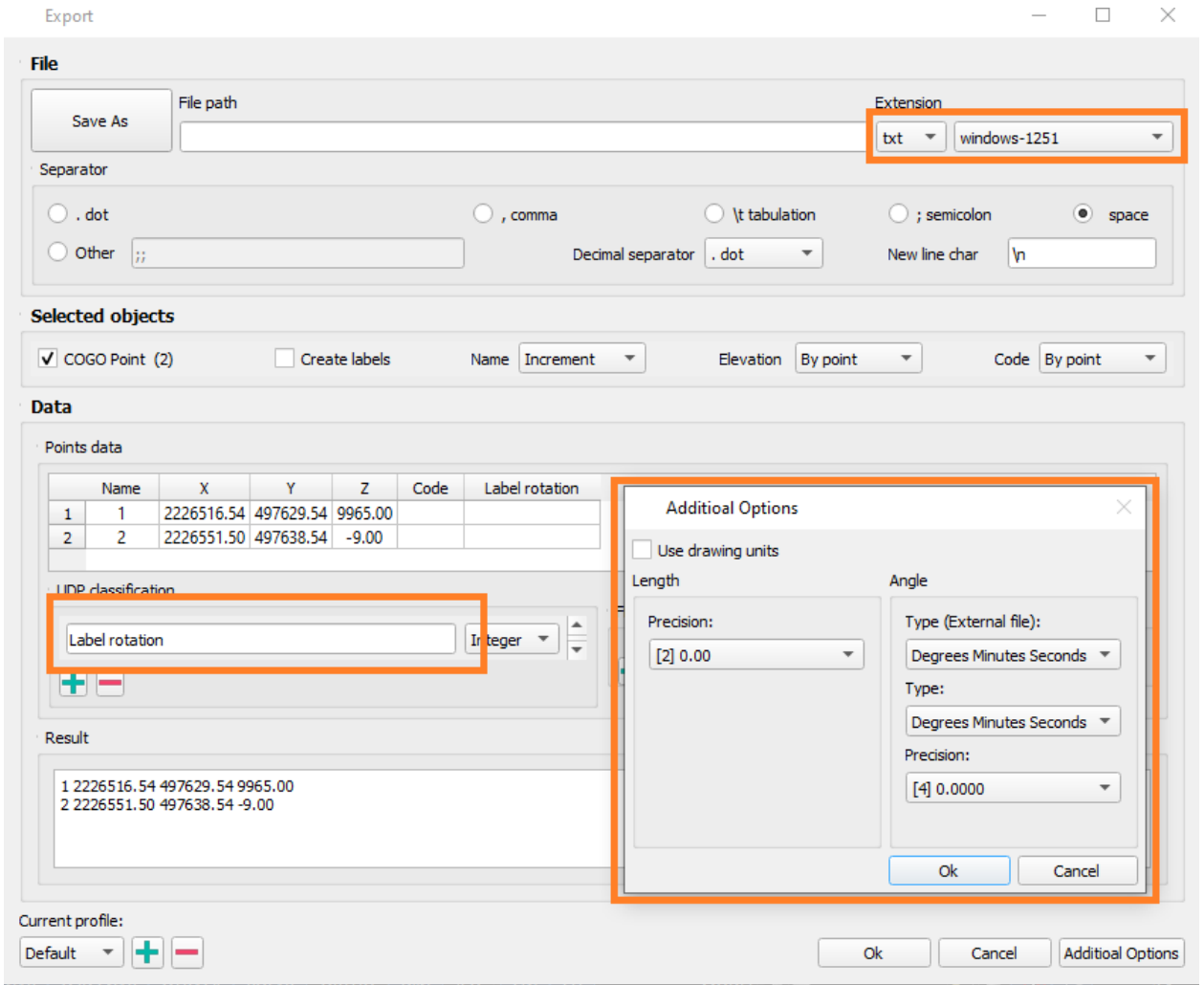

## Points Conversion

The **Convert Points** (NG\_CONVERT\_POINTS) command allows you to convert point objects: points to geopoints and blocks, blocks to points and geopoints, geopoints to points and blocks.

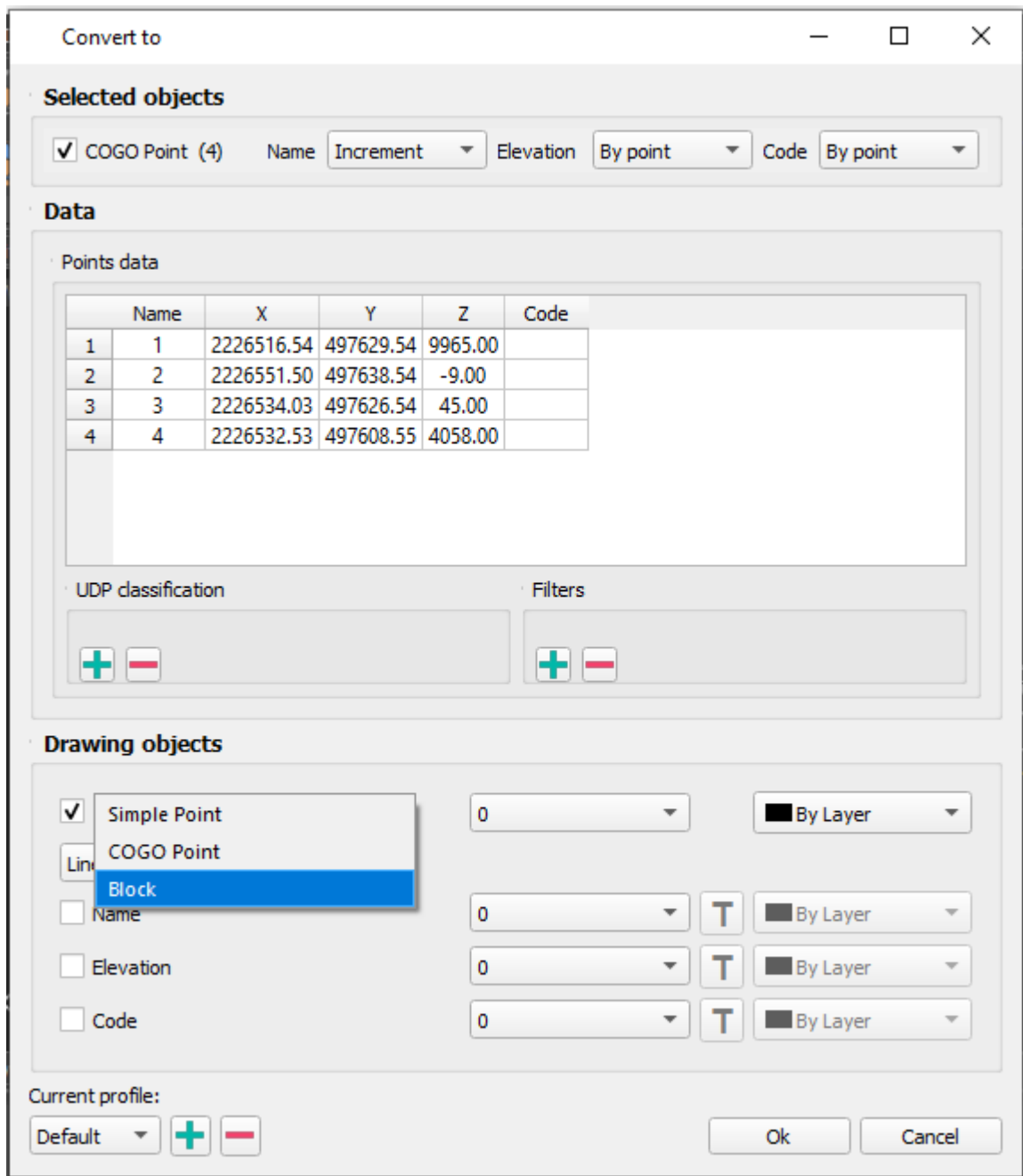

## Creating Label and Marker Styles of Geopoints

It has become possible to create custom label and marker styles for geopoints from the context menu of the appropriate sections of the **Drawing Manager** (C3D\_CREATE\_COGO\_MARKER\_STYLE, C3D\_CREATE\_COGO\_LABEL\_STYLE).

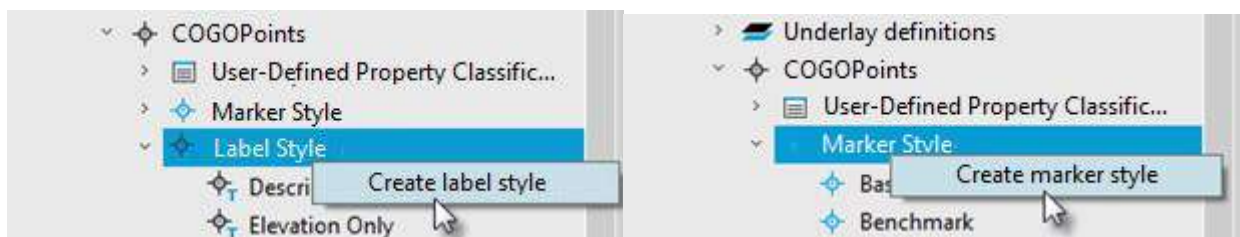

The parameters of the created styles are configured in the **Properties** bar.

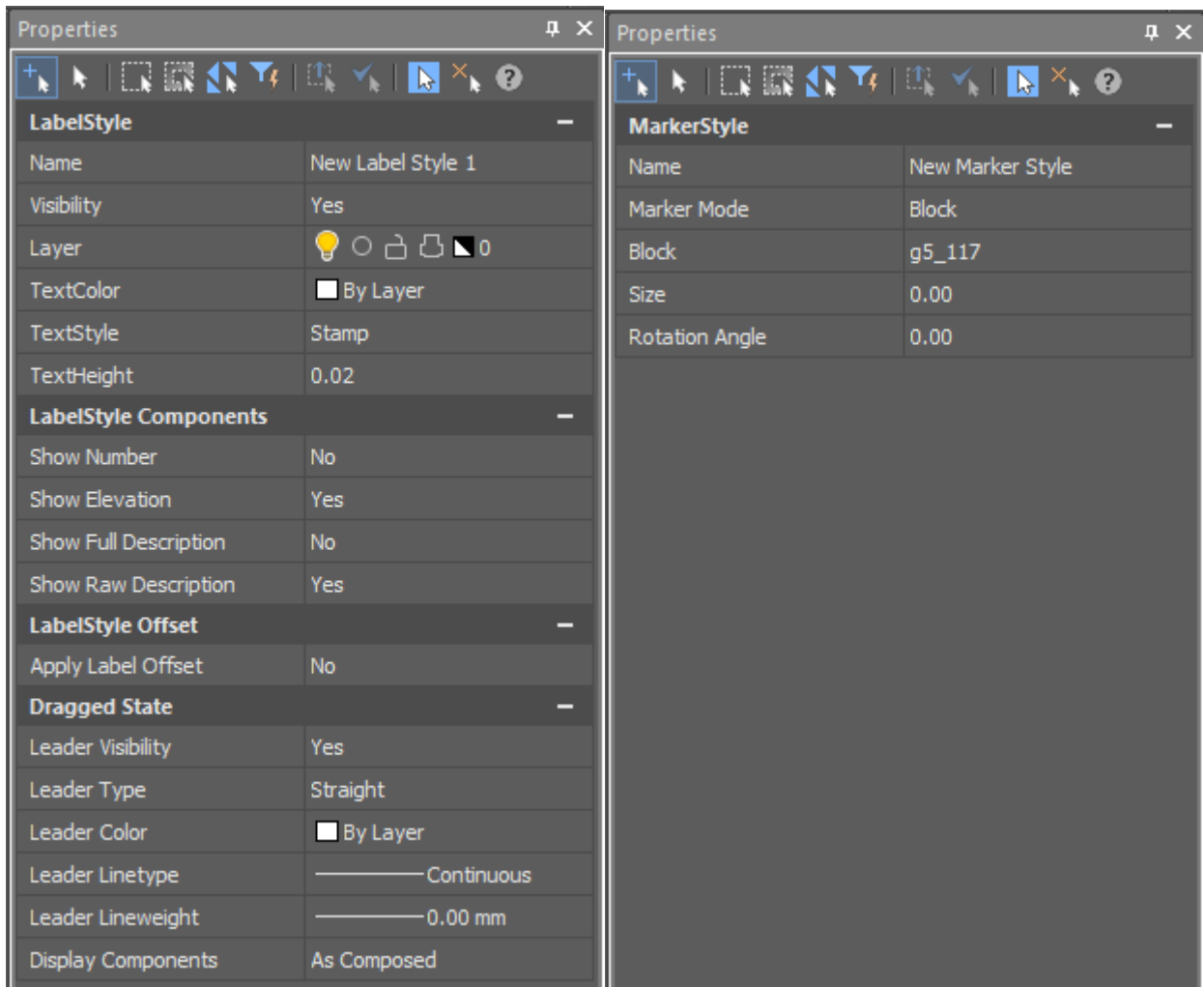

## Editing Marker Style and Label Style Properties

Editing properties of label styles is started by double clicking on the required label style in the **Drawing Explorer**. The parameters are set in the **Properties** bar.

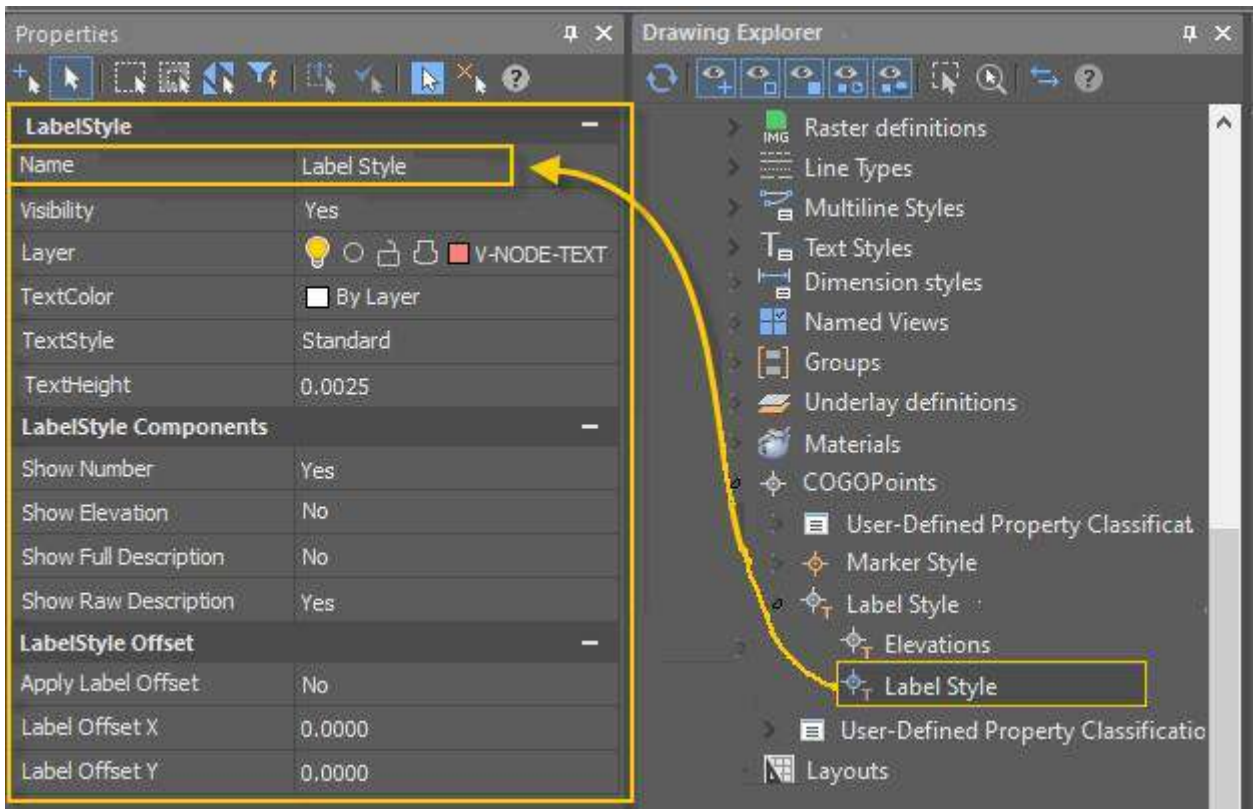

Editing properties of marker styles is started by double clicking on the required marker style in the **Drawing Explorer**. The parameters are set in the **Properties** bar.

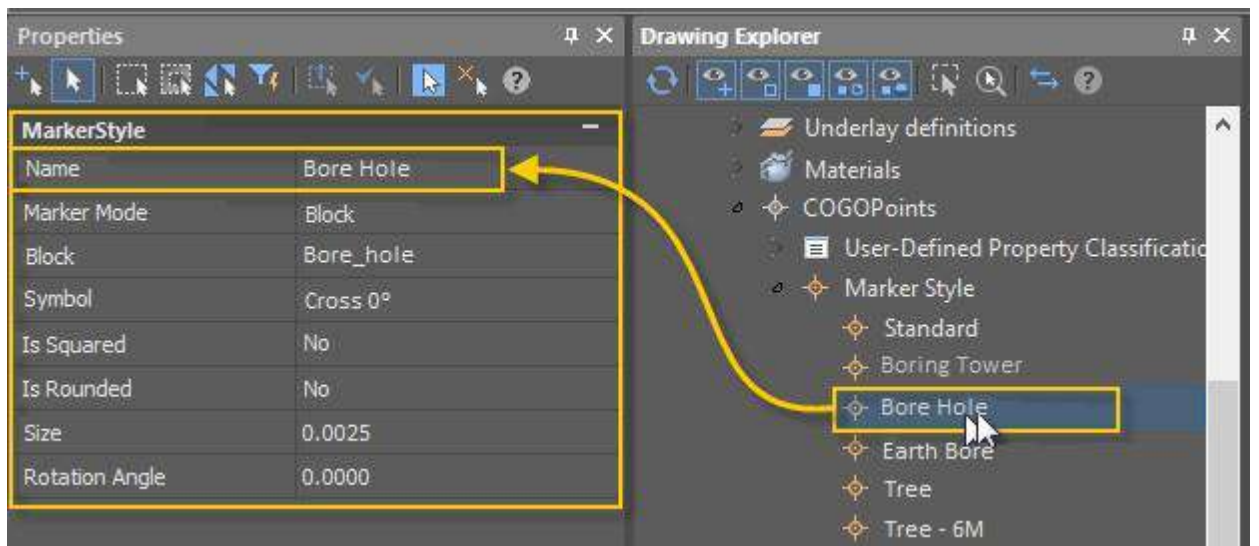

## User-Defined Properties of Geopoints

You can set user-defined properties for geopoints. If you have additional data that cannot be distributed over existing standard geopoint properties, you can define your own user-defined properties.

There are four types of user-defined properties available:

- **String:** allows you to enter text as a value. Is used when you want to enter any alphabetic or numeric characters.



- **Integer:** allows you to enter only whole numbers without decimals.
- **Double:** creates a property that allows you to enter numbers with decimal places.
- **Boolean:** creates a property that allows you to switch Yes/No (“true” or “false”) value.

User-defined properties of geopoints are grouped into user-defined property classifications. A classification can be created, filled with user-defined properties or deleted.

Thus, if you have a survey that contains tree data, you can create the **Trees** classification. Then create user-defined properties related to this classification in it.

For example:

- **Name** (string),
- **Deciduous** (boolean),
- **Elevation** (double).

All user-defined properties of geopoints and their classifications are displayed in the **Drawing explorer (Drawing Settings – COGOPoints – User-Defined Property Classification)**.

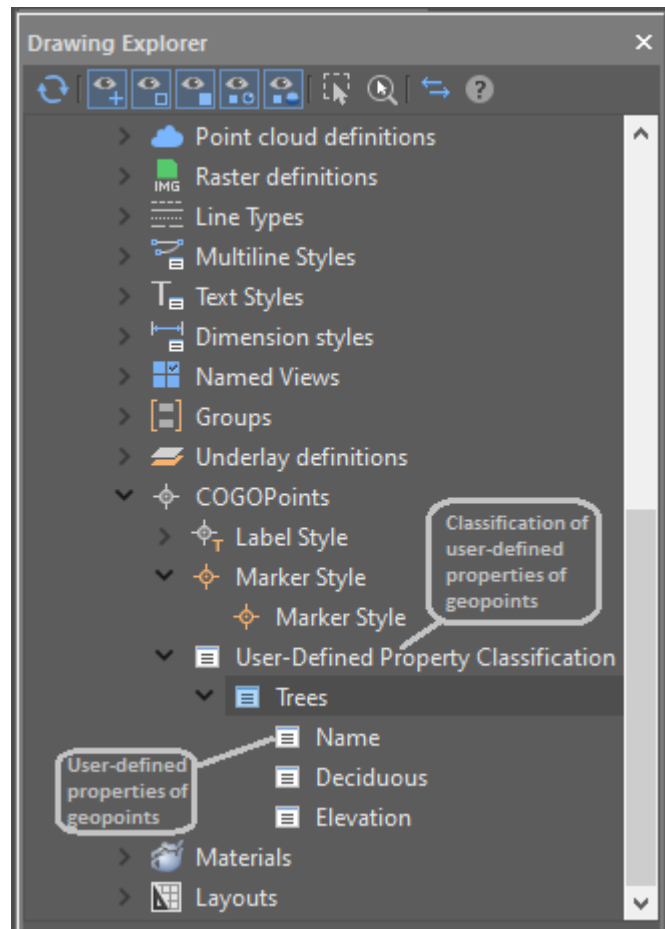

You can view and edit the values of user-defined properties of the drawing geopoints in the **Properties** bar.

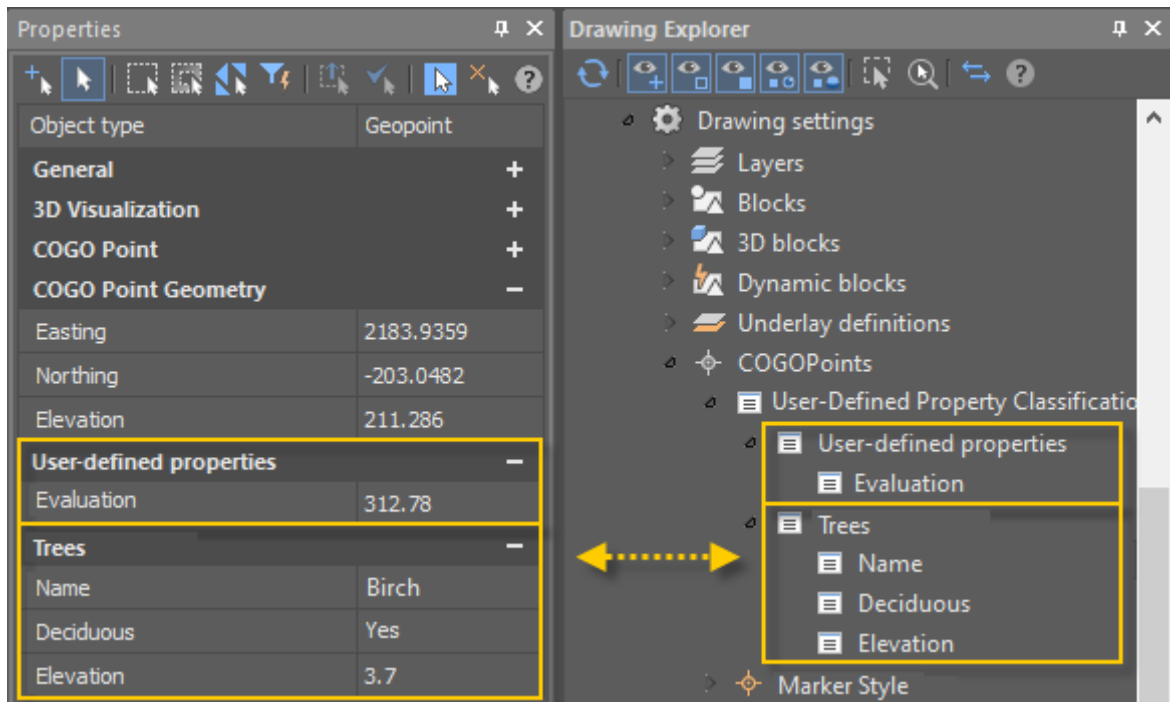

You can create a new user-defined property classification by selecting **Create** in the context menu of the **Drawing Settings – COGOPoints – User-Defined Property Classification** in the **Drawing Explorer**. The name of the new classification is entered from the keyboard:

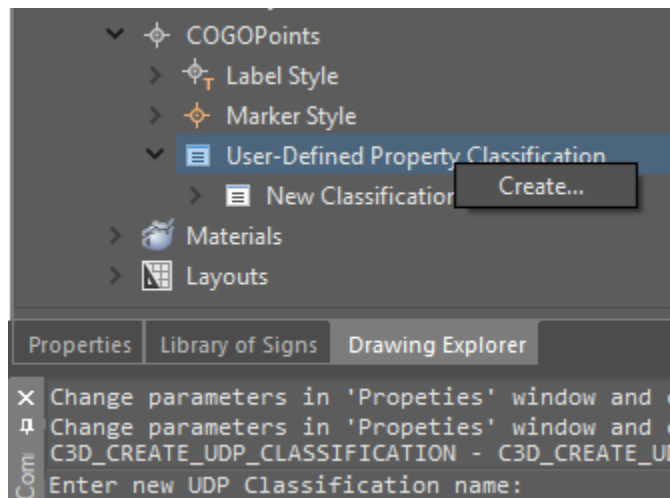

You can create a new user-defined property by selecting **Create** in the context menu of any user-defined property classification in the **Drawing Explorer**.

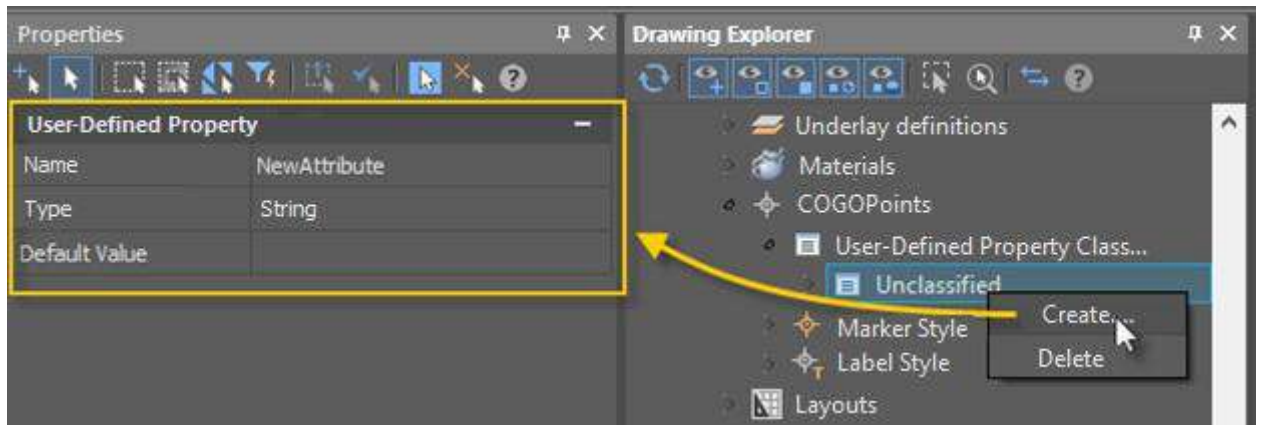

User-defined properties can also be [assigned during the import of geopoints](#) by the **Import Geopoints** command.

You can delete a classification or a user-defined property by selecting **Delete** in its own context menu in the **Drawing Explorer**.

## Batch Upload of Georeferenced Rasters

The **Import georeferenced rasters** (NG\_IMPORT\_RASTERS) command is intended for batch loading of georeferenced rasters in TIF, ECW formats.

This allows you to quickly form high-quality underlays from large orthophotomaps, previously divided into component parts.

## Search for Key Lines on the Surface

The **Search for key lines on surface** (NG\_KEY\_LINES) command searches for key lines (thalwegs, ridges, etc.) across the surface.

## TOPOPLAN MODULE. UPDATED FUNCTIONALITY

### Deleting an Edge

The **Delete Edge** command (NG\_MESH\_EDGE\_DELETE) now has the possibility for group deletion of edges.

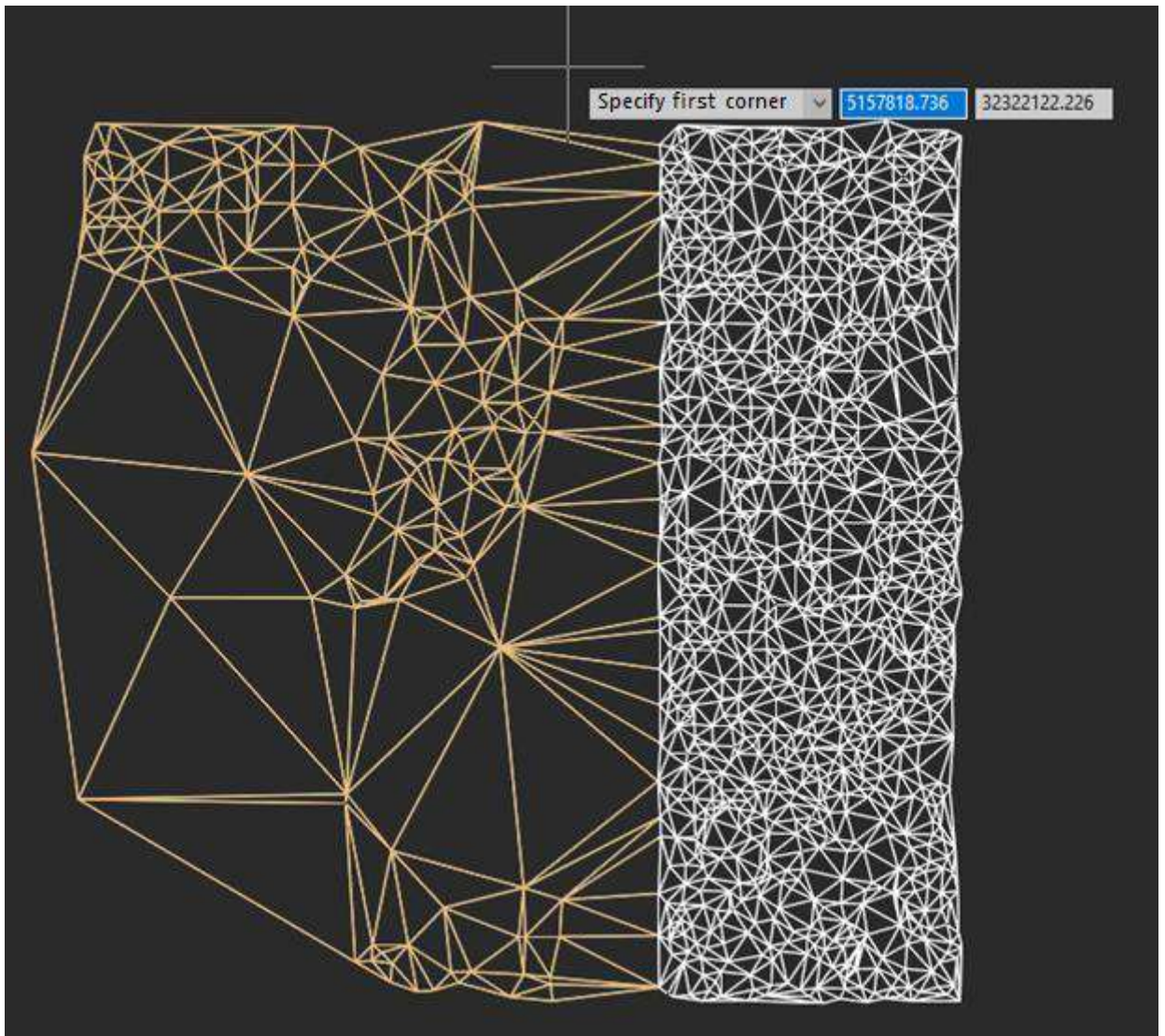

## Painting Mesh by Elevation

New parameters and interface of the **Paint mesh by elevation** (NG\_PAINT\_ELEVATION) command now allow to:

- Configure coloring gradient;
- Specify minimum and maximum values;
- Set color outside the specified range;
- Select the gradient type (continuous or discrete);
- Save gradient to file and import gradient from file.

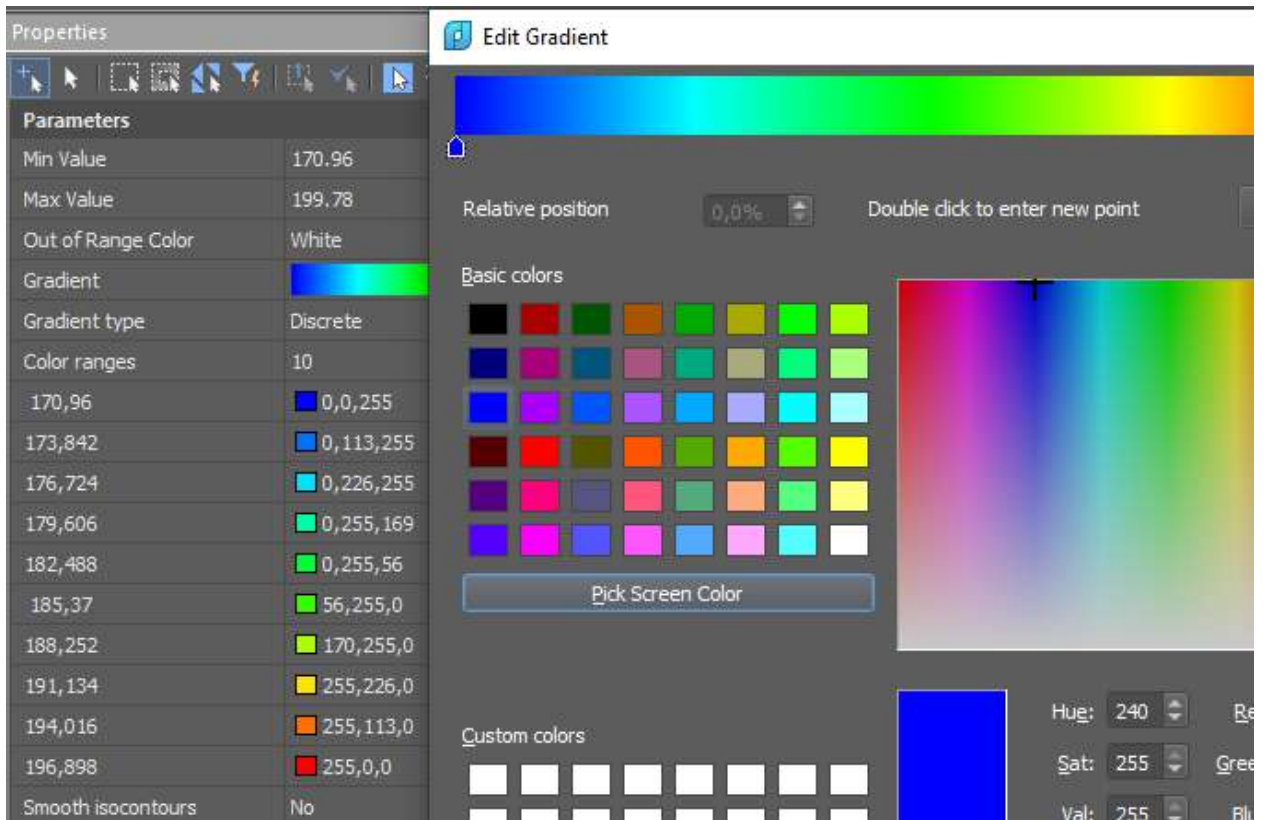

## Import Geopoints

In the **Import Geopoints** (NG\_IMPORT\_POINTS) command:

- The **Additional options** have appeared, where you can specify the accuracy of linear and angular units for import;

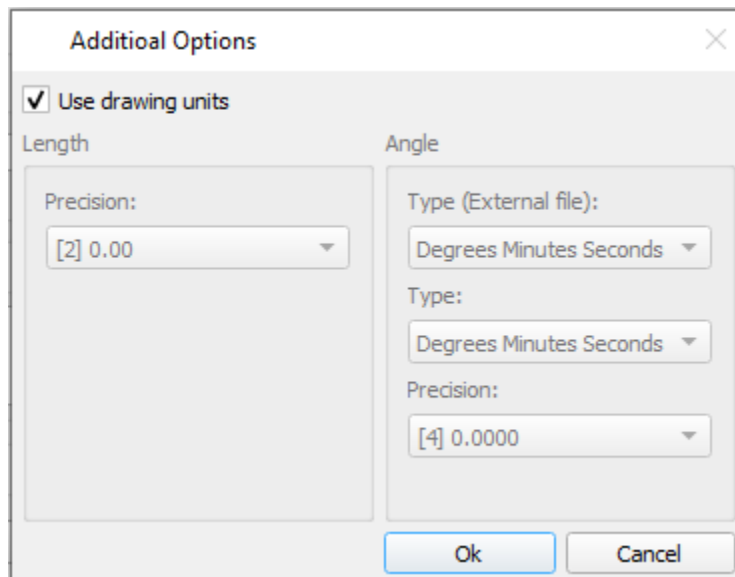

- The possibility to select encoding has been added.
- The possibility to specify the projection EPSG code to convert imported points has been added.

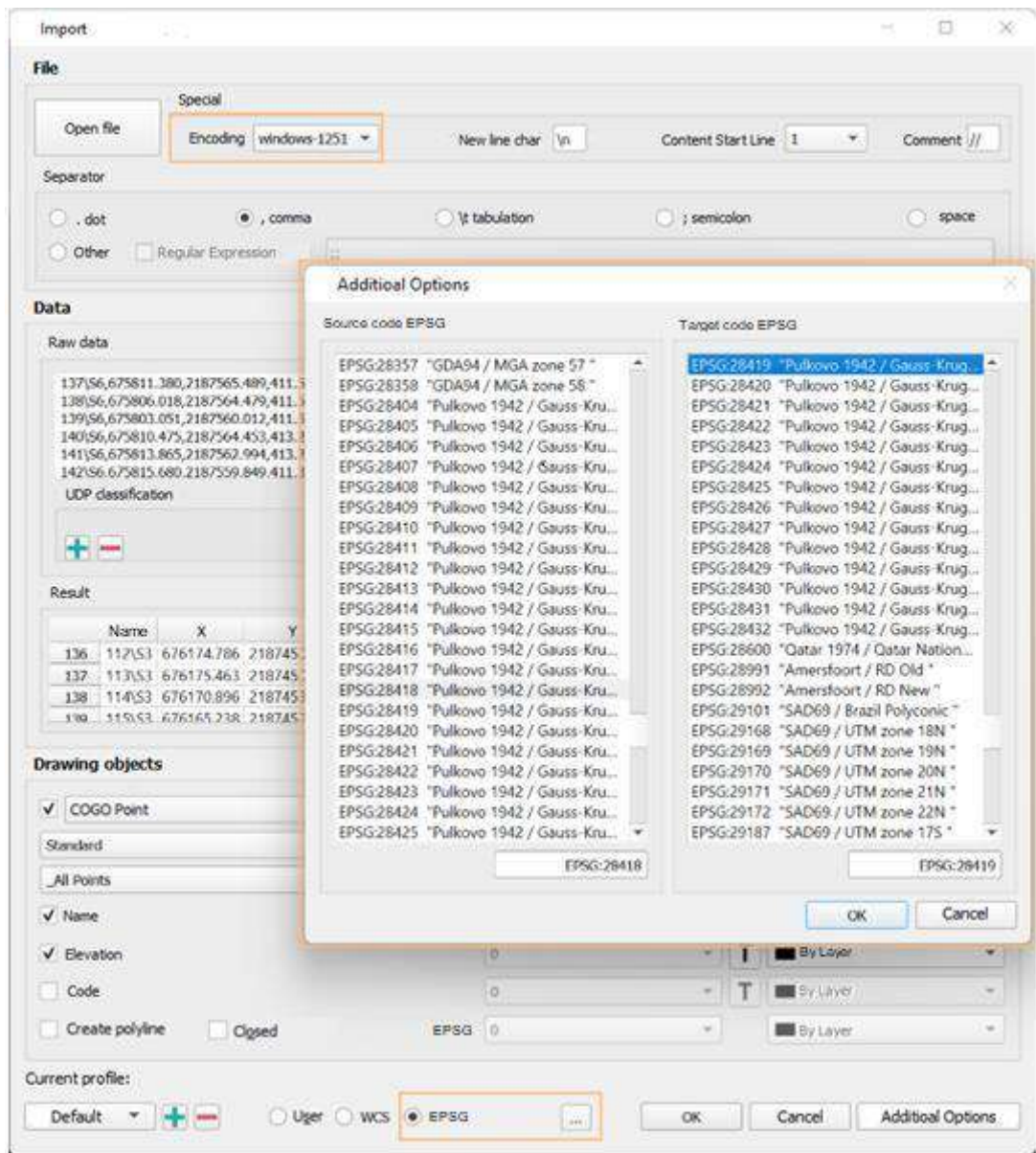

## Improved Import of Geopoints

### Creating User-Defined Properties of Geopoints

The possibility to create new properties for points has been added to the dialog box of the **Import geopoints** (NG\_IMPORT\_POINTS) command. When adding a property, a new column appears in the result table:

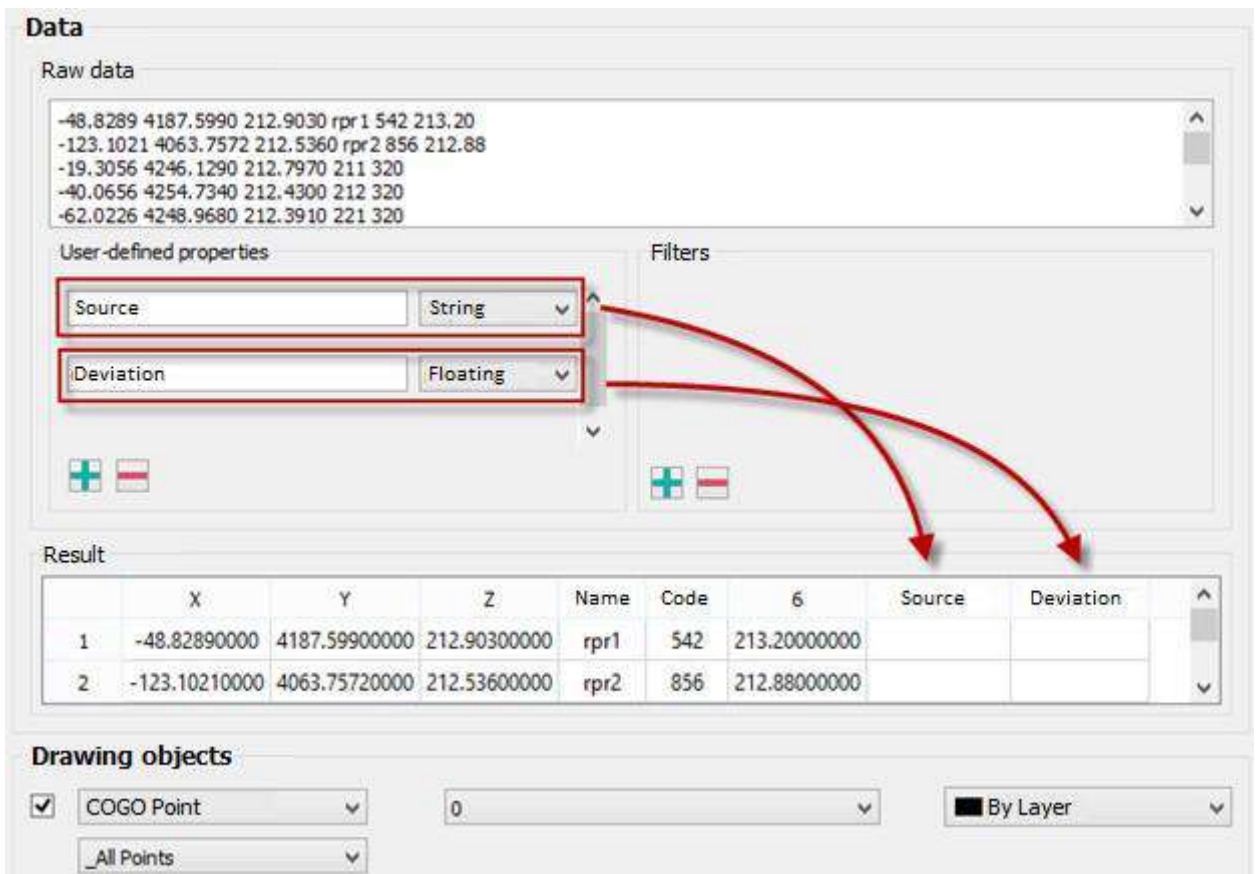

The imported points will obtain these properties:

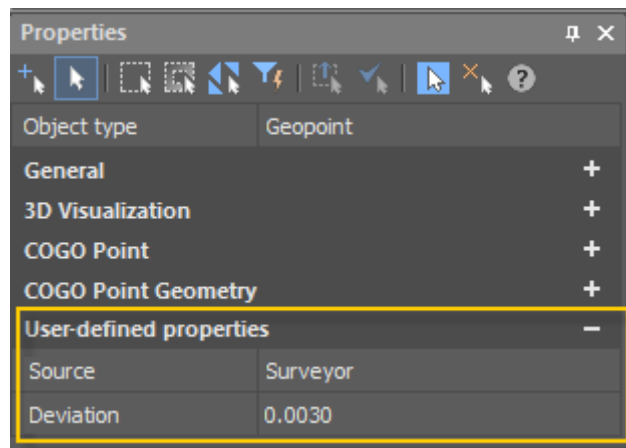

## Improved Data Typing

The mechanism for matching text file columns to certain data types has been improved. The column heading displays the data type. In case of incorrect initial data typing, it is necessary to drag one column to another by the header. At that, previously the data in these columns used to change mutually.

	Name	X	Y	Z	Code
1	3602926.4336	103	1145223.8177	56.3565	Road
2	3602926.7140	102	1145224.3639	56.3777	Road
3	3602925.6367	104	1145223.0935	56.3256	Road

	Name	X	Y	Z	Code
1	103	3602926.4336	1145223.8177	56.3565	Road
2	102	3602926.7140	1145224.3639	56.3777	Road
3	104	3602925.6367	1145223.0935	56.3256	Road

Now it is not the content of the columns that change, but the headings themselves. The data remain in place.

	Name	X	Y	Z	Code
1	3602926.4336	103	1145223.8177	56.3565	Road
2	3602926.7140	102	1145224.3639	56.3777	Road
3	3602925.6367	104	1145223.0935	56.3256	Road

	X	Name	Y	Z	Code
1	3602926.4336	103	1145223.8177	56.3565	Road
2	3602926.7140	102	1145224.3639	56.3777	Road
3	3602925.6367	104	1145223.0935	56.3256	Road

In addition, now when you hover over the column header and drag it, the cursor changes its appearance.



### Other Improvements of Geopoints Import

Points inserted as blocks now take into account the drawing scale. Previously, points in the form of blocks were always inserted with the same scale.

	1:500	1:1000	1:2000	1:5000
Insertion from OS bar	• 100	• 100	• 100	• 100
Import	•	N277 • 287.594	N277 • 287.594	N277 • 287.594

The situation when while launching the **Import Geopoints** (NG\_IMPORT\_POINTS) command the dialog did not display a list with the name of existing groups of geopoints (or the ability to create geopoints) has been fixed.



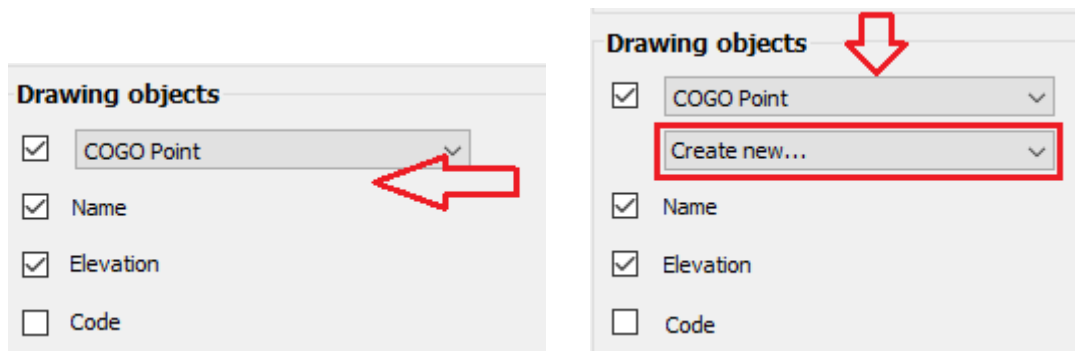

Now the name of the block being created after importing block geopoints does not contain the date.

Now, in the geopoints import dialog box, the names of existing blocks are now sorted in order. Previously, when importing geopoints from a TXT file in the form of blocks, the search for the required block took considerable time.

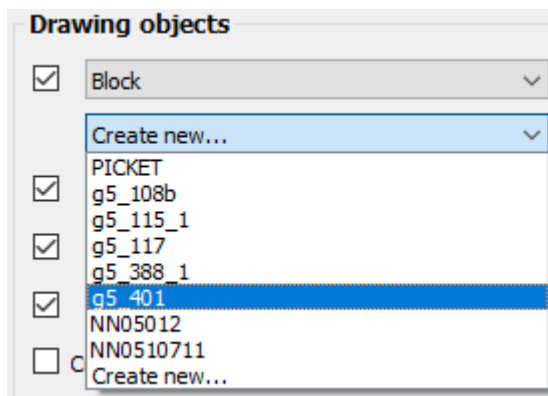

An incorrect behavior after expanding groupboxes has been fixed: even those objects that should have been hidden became visible.

A case sensitivity in the font selection subdialog has been removed.

The situation has been fixed when, while importing several files at once, the creation of entities was repeated as many times as many files was opened.

The incorrect table behavior when importing multiple files has been fixed. With multi-selection of files, changing the beginning of a new line changed the general list, but not the result for each file individually.

## KML/KMZ Import

Import from KML/KMZ-format (Keyhole Markup Language) has been realized with the possibility to recalculate data from/ to various topographic and geodetic coordinate systems using EPGS codes (KMLIMPORT command).

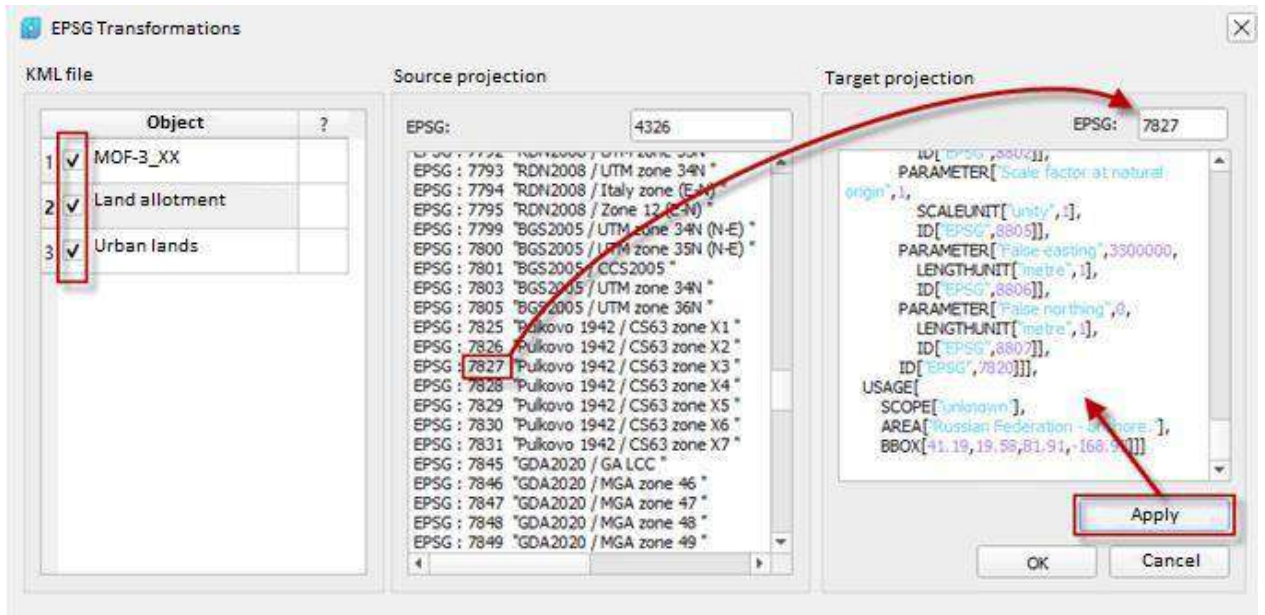

## Import of KML/KMZ files

In the **Import KML/KMZ files** (KMLIMPORT) command:

- The dialog box, in which the downloaded files are now displayed on the globe, with the possibility to select a map or a satellite image, has been updated.
- Search by number, projection name and display of the selected projection parameters have appeared.

- After importing objects, these objects are zoomed in the drawing.

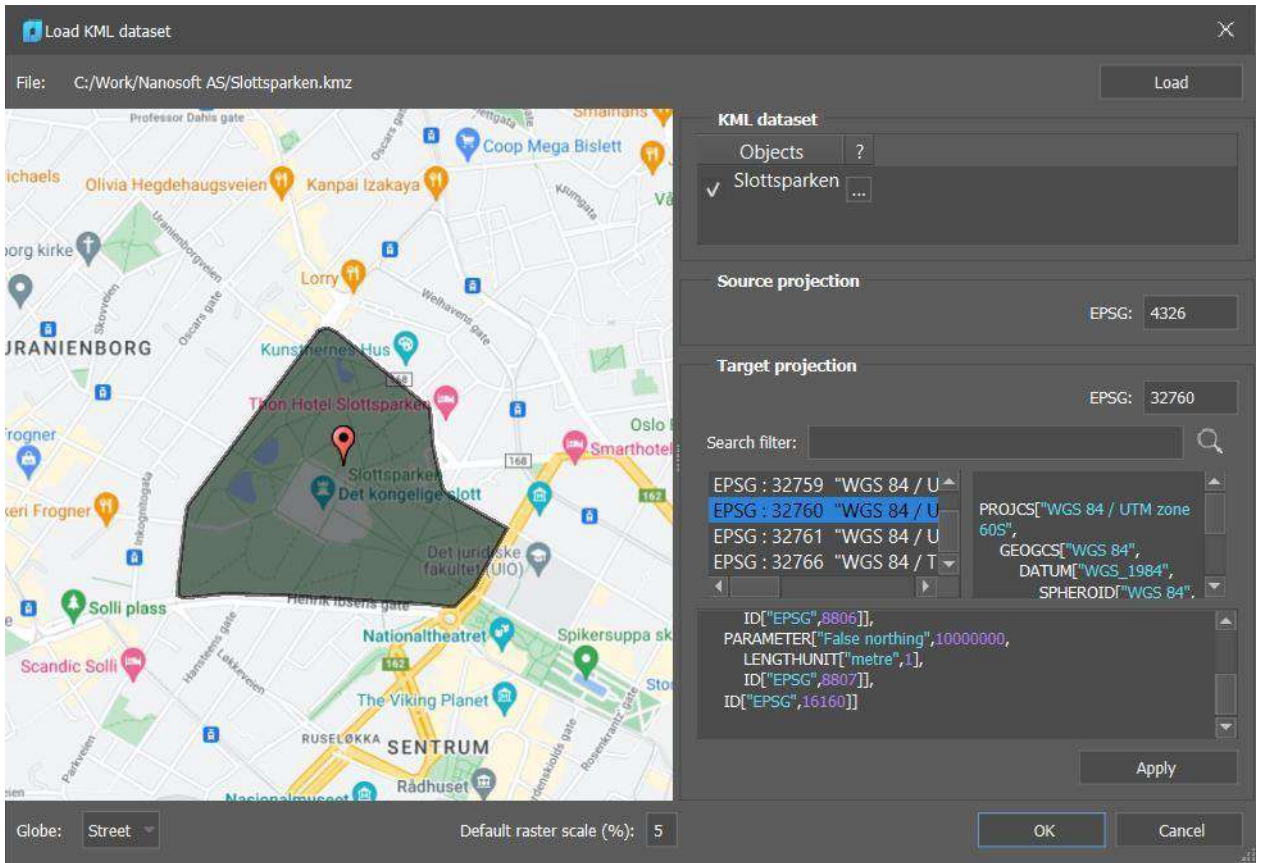

## Changing the Scale of Geopoints and Conventional Signs

When changing the topographic scale, a proposal appears to change the scale for geopoints inserted into the drawing and the conventional signs of the classifier (blocks).

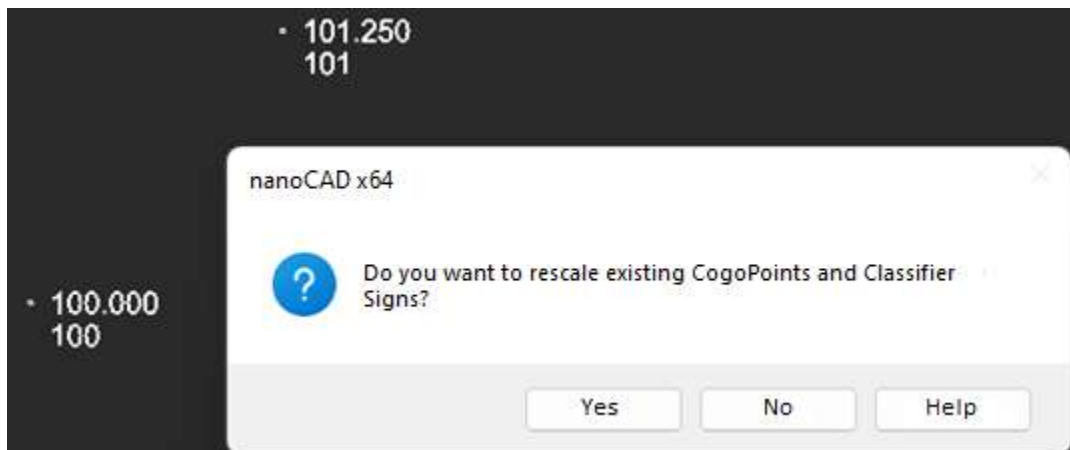

## Creating TIN by Points

In the **Create TIN by Points** (NG\_CREATE\_TIN) command:

- It has now become possible to select user attributes for obtaining a mark (Z coordinates) when constructing a surface by geopoints.
- Filtering by the angle between edges when creating a surface has been added.

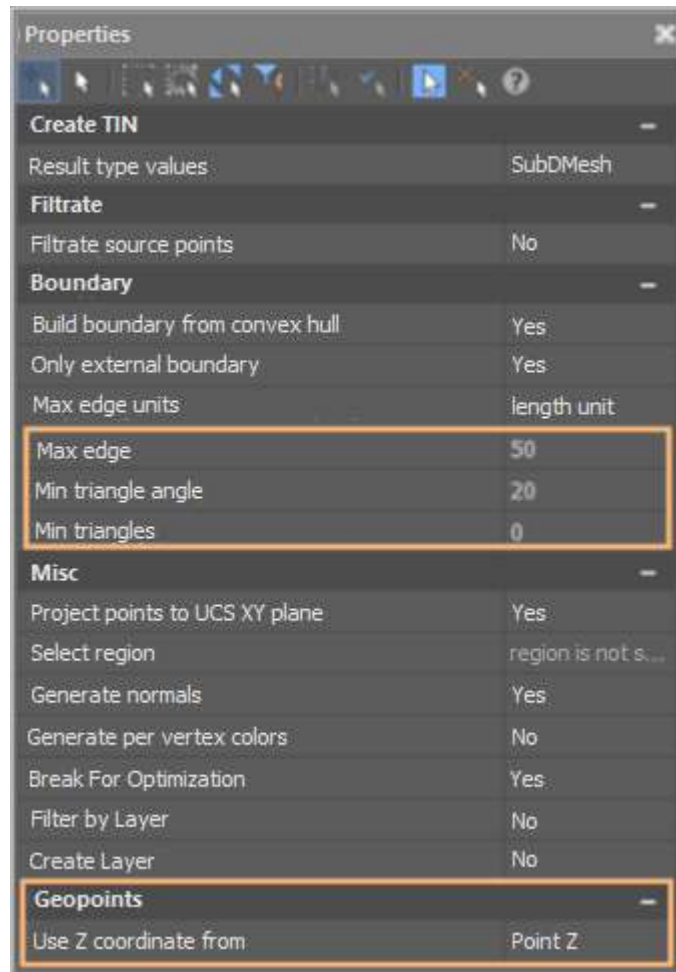

## Changing the Anchor Point when Inserting Layout Frames

The possibility to change the anchor point when inserting frames to form layout viewports in the **Create View Frames** command has been added.

Changing the anchor point of the frame is convenient in case of designing routes, because they can go in any direction. This is also true for tablets, where usually the numbering goes from left to right and from top to bottom. But when you try to insert the second row, it is already inconvenient to use the anchor point from the bottom left.

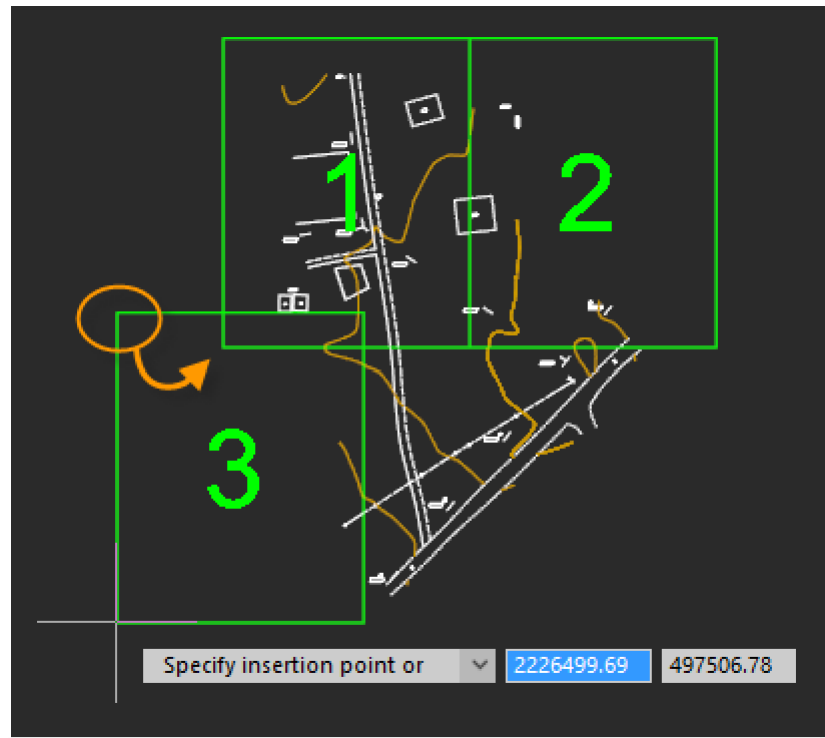

For cycle change of the anchor point, just press the **Spacebar** key or select the **Anchor point** keyword. Anchor point can be set to any vertex of the frame:



## Precise Shape of Layout Frames

In previous versions, the layout frames created by the **Create Layouts for Frames** command were quadrangular and did not take into account the position of the stamp. Now the frames profile fully corresponds to the boundaries of the viewport of the layout, which is created on their basis by the **Create Layouts by Frames** command.

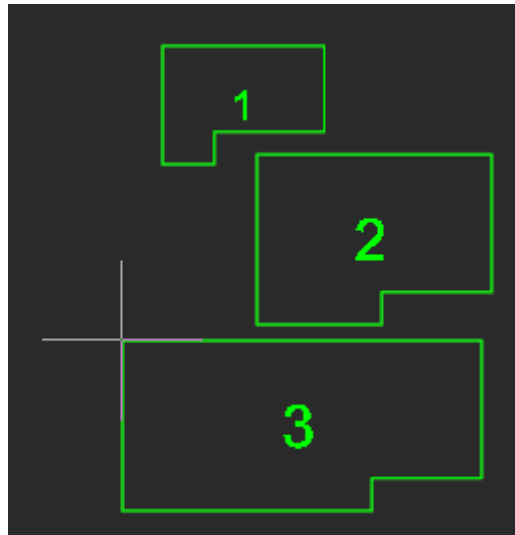

This is especially important for the A4 landscape format, where the stamp occupies a significant part of the layout and it is difficult to predict whether the model will fit in the future viewport, or its part will be covered by the stamp.



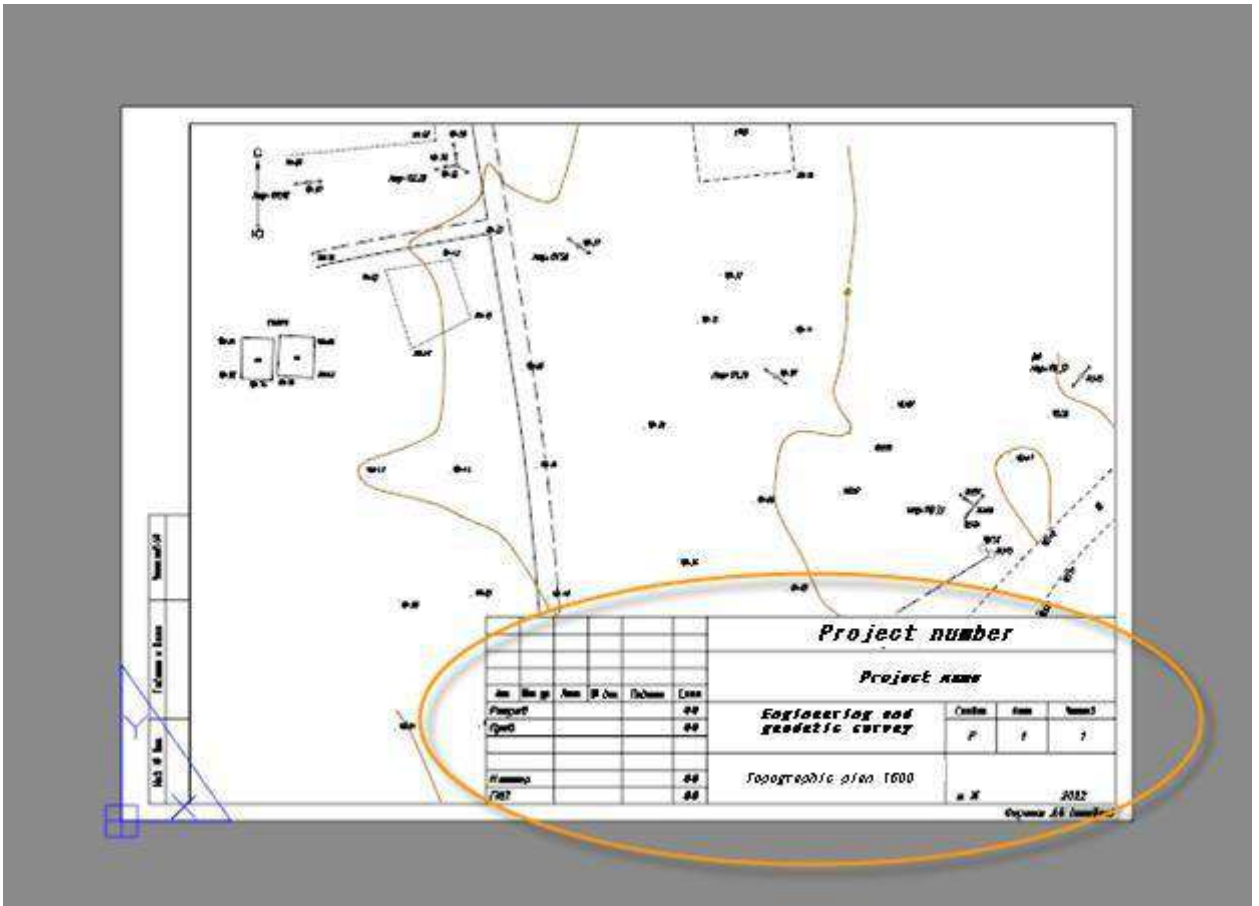

## Other Developments and Improvements

Now automatic panning is performed after importing data from the LandXML format using the **Import from LandXML** (NPC\_IMPORT\_LANDXML) command.

Display of two parameters of the **Volume between Models** (NG\_VOLUMES) command in the **Properties** bar has been fixed.

A ban on creating custom properties without a name has been introduced.

Such properties as **Locked** (prohibition of moving, copying, stretching geopoints) and **Label Visibility** (showing/hiding labels, regardless of the style configured for them) now work in geopoints.

The bug with the appearance of masking when moving a geopoint label has been fixed.

The possibility to rotate a geopoint label if the label was moved has been added.

Support for smooth contours on Civil 3D surfaces:

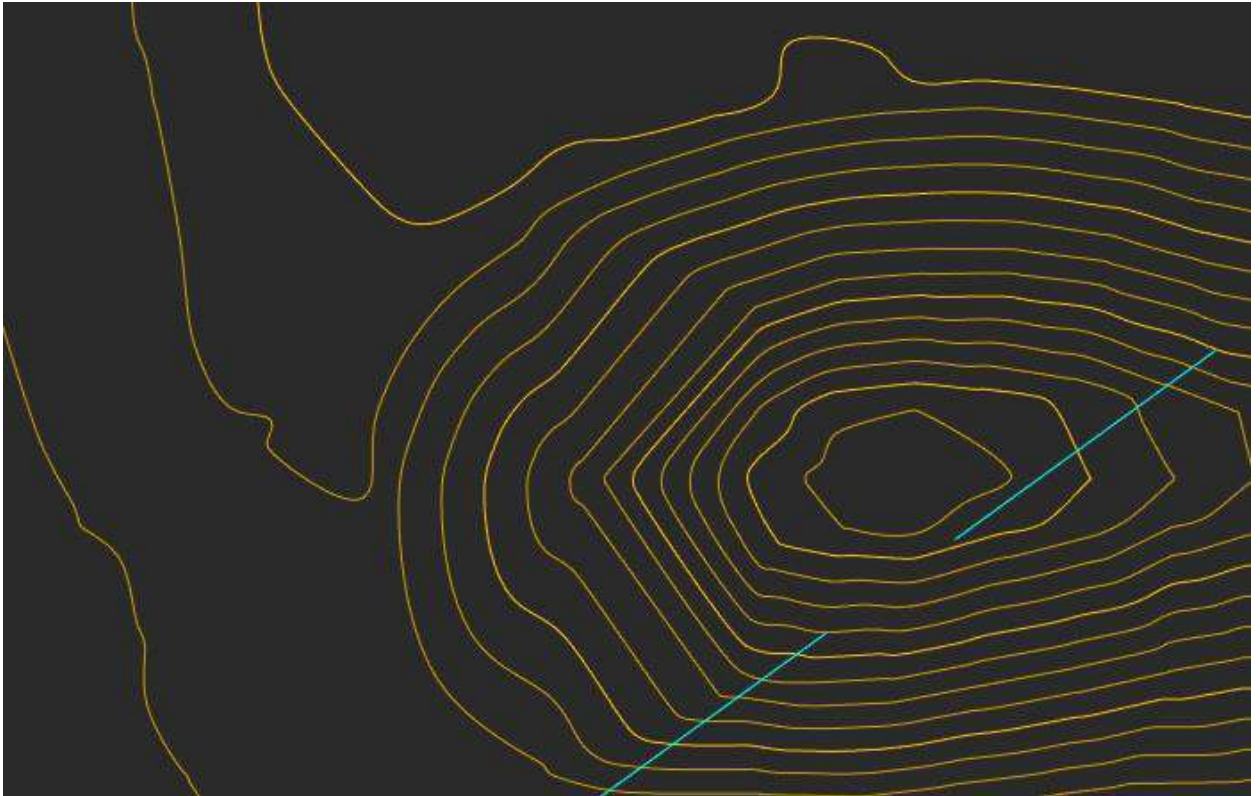

When creating the style of labels (C3D\_CREATE\_COGO\_LABEL\_STYLE) and markers (C3D\_CREATE\_COGO\_MARKER\_STYLE) for geopoints, the bar is now automatically updated.

## 3D MODULE

\* The most up-to-date and complete description of the new features of 3D Module is available [online](#).

### 3D History

The 3D History now displays the results of the new command of the Mechanics module – **Flanging**.

A possibility to change the construction order in the 3D history tree has been implemented, an element of the end of the 3D construction history has appeared. Now the history elements can be swapped if it does not destroy the model, as well as hide some of the elements (for example, to analyze the model).



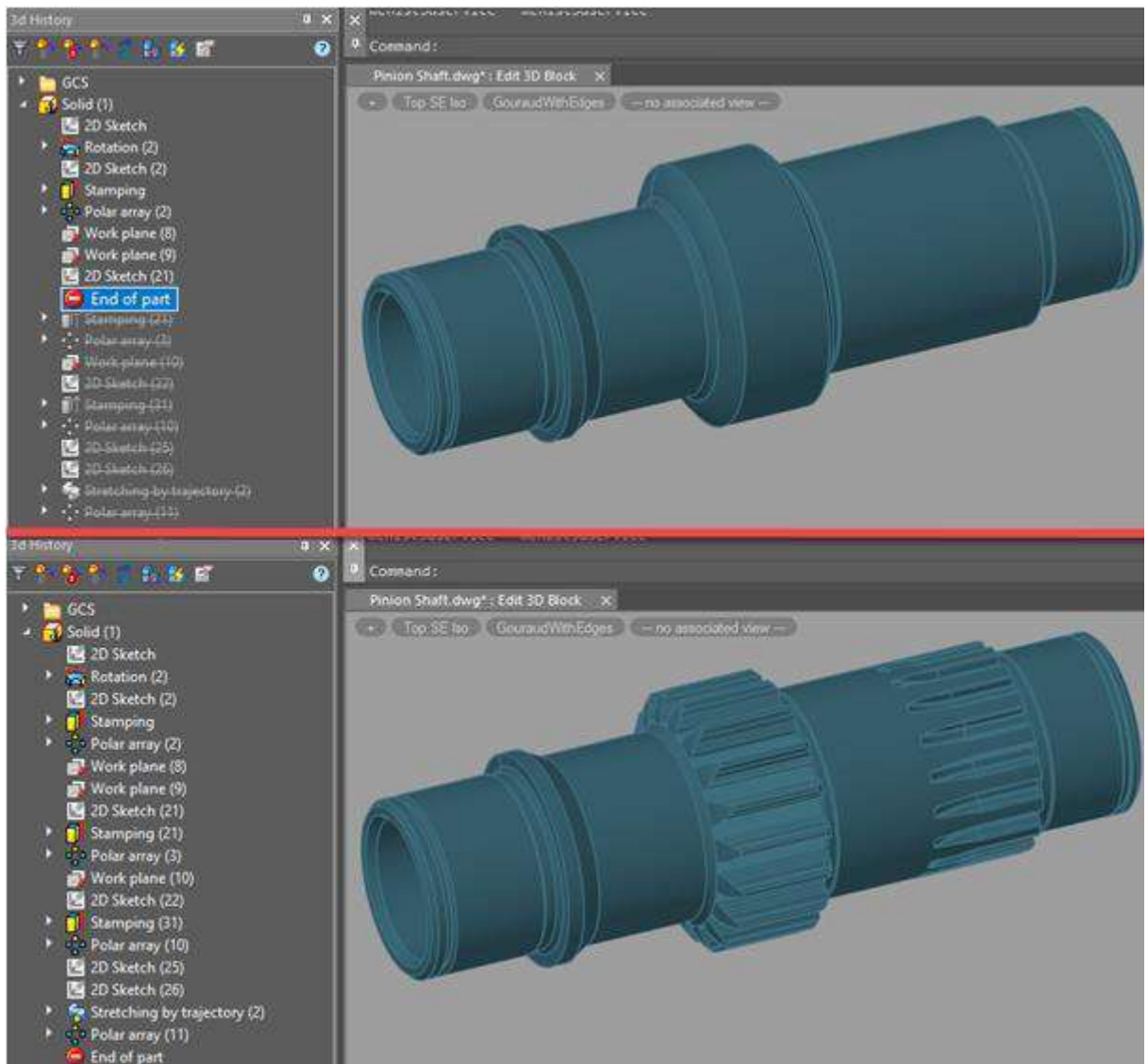

## Presspull

In the **Presspull** (PRESSPULL) command now it has become possible to move part of a selected face.

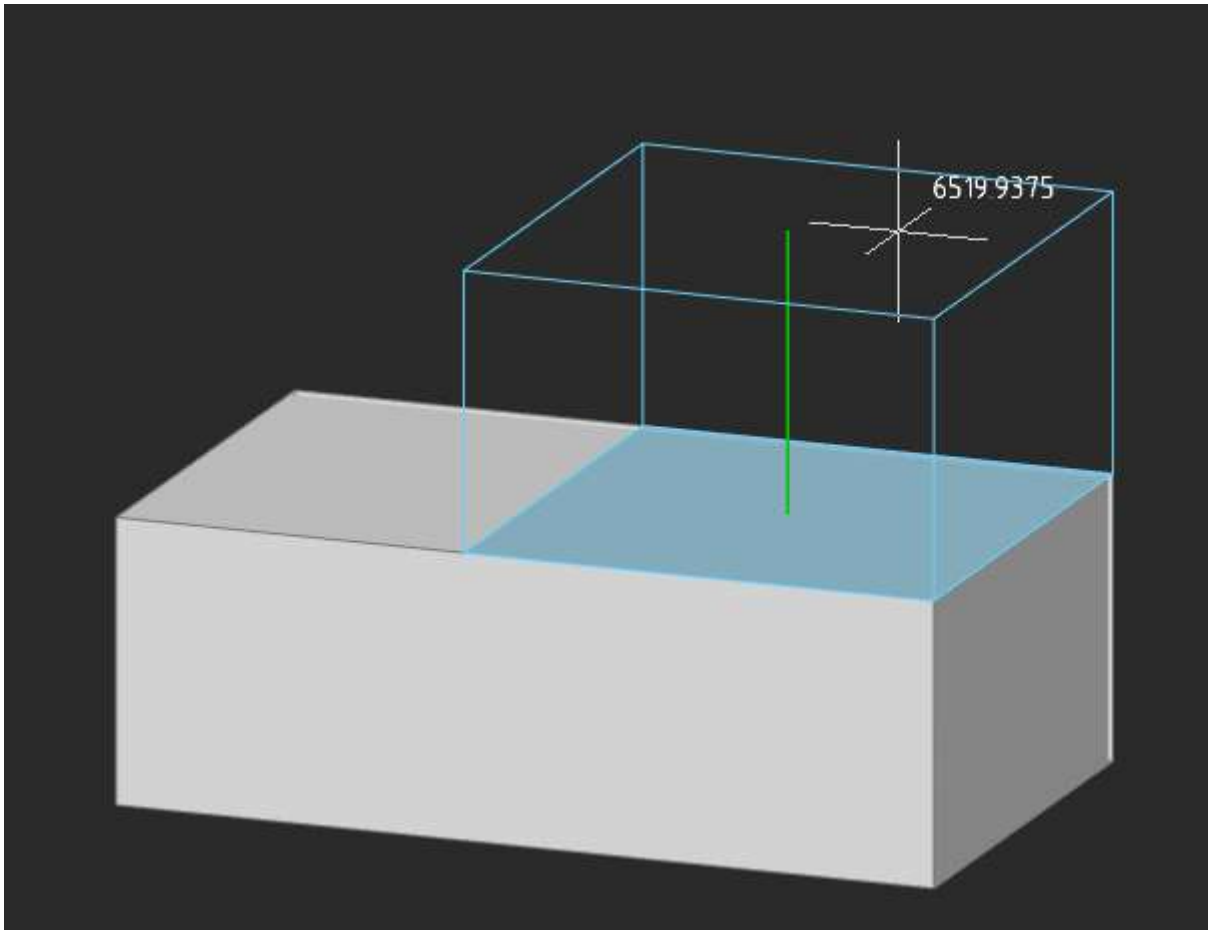

## Extrusion

The **Extrude** (EXTRUDE) command now takes into account internal closed contours (holes).

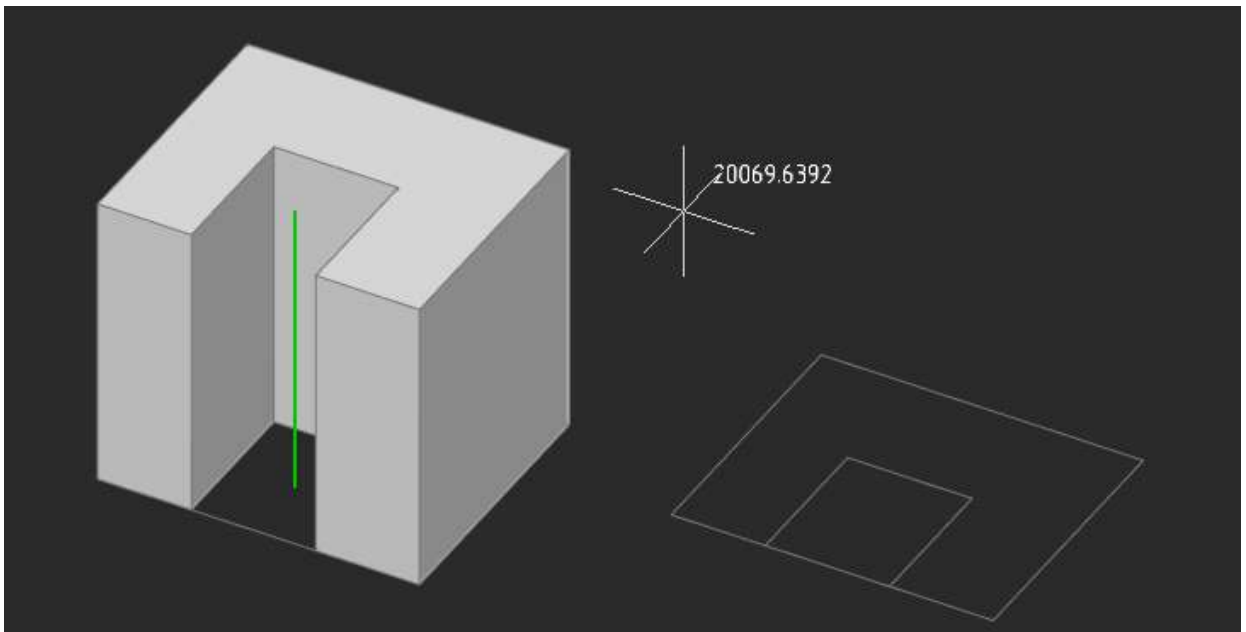

## Face Alignment

In the **Presspull** (PRESSPULL) and **Extrude** (EXTRUDE) commands, a possibility has been added to align 2 faces: one created using extrusion and one created on the model.

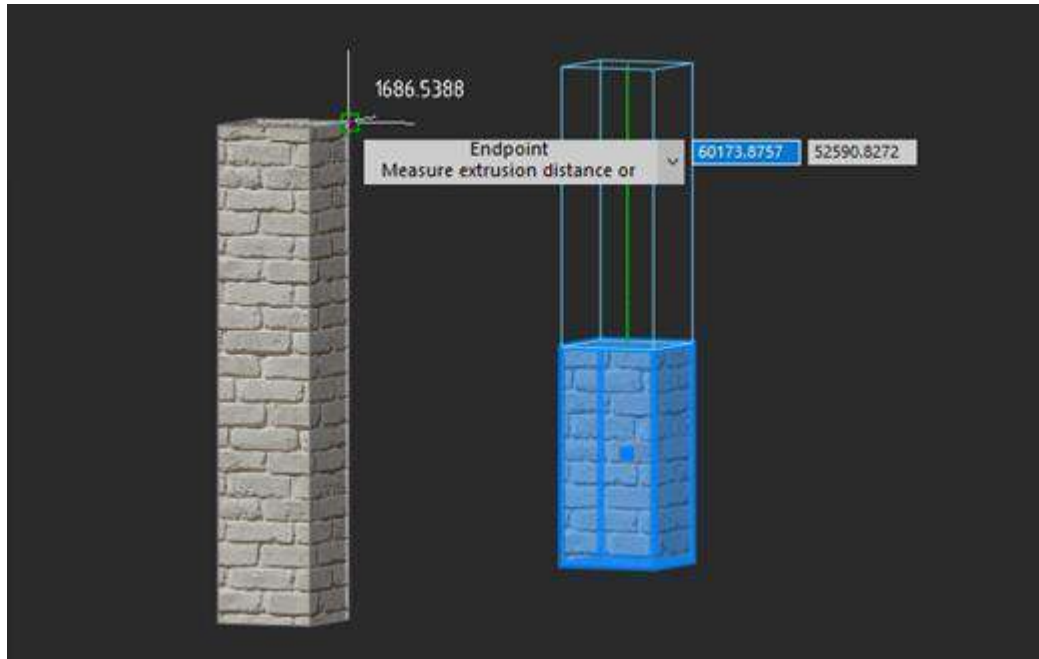

## Stretching by Sections

In the parametric modeling mode, it has become possible to create a model with a hole in the **Stretching by sections** mode.

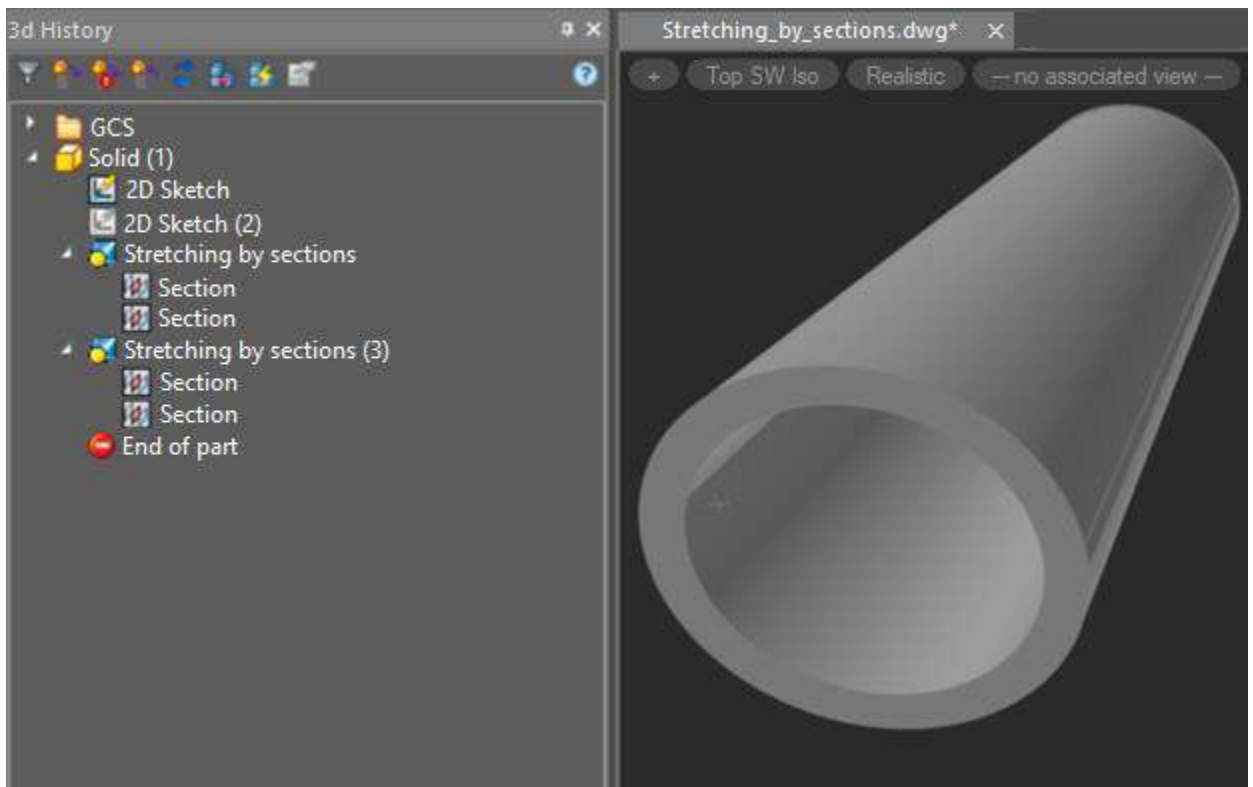

# Parameters Manager

A search bar has appeared in the **Parameters Manager** window.

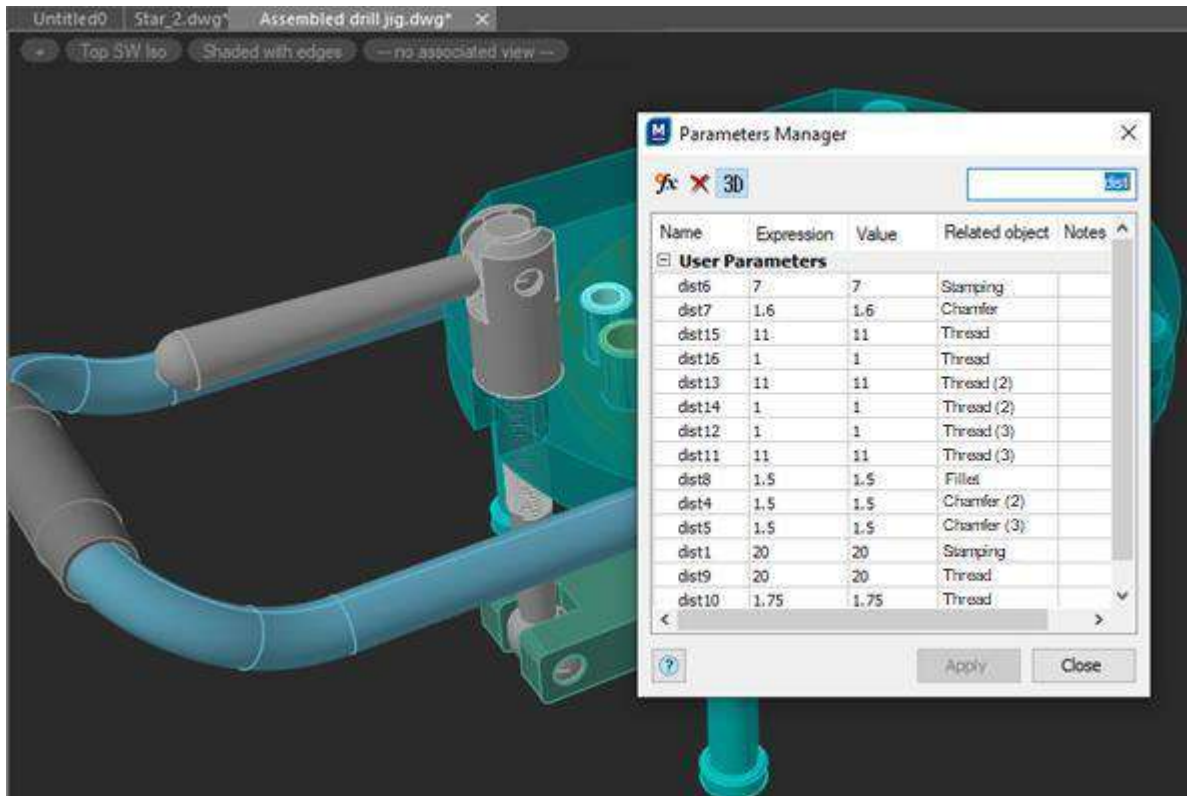

## NEW IN 3D MODULE

Now you can edit the color of lines and text of dimensional constraints. Often, such constraints were very difficult to distinguish on the screen, especially when the grid was on. The `DYNCONSTRAINTSCOLOR` and `DYNCONSTRAINTSTXTCOLOR` system variables are responsible for these colors, and you can set the color in the **Color > Dimensional constraints** of the **Options** dialog.

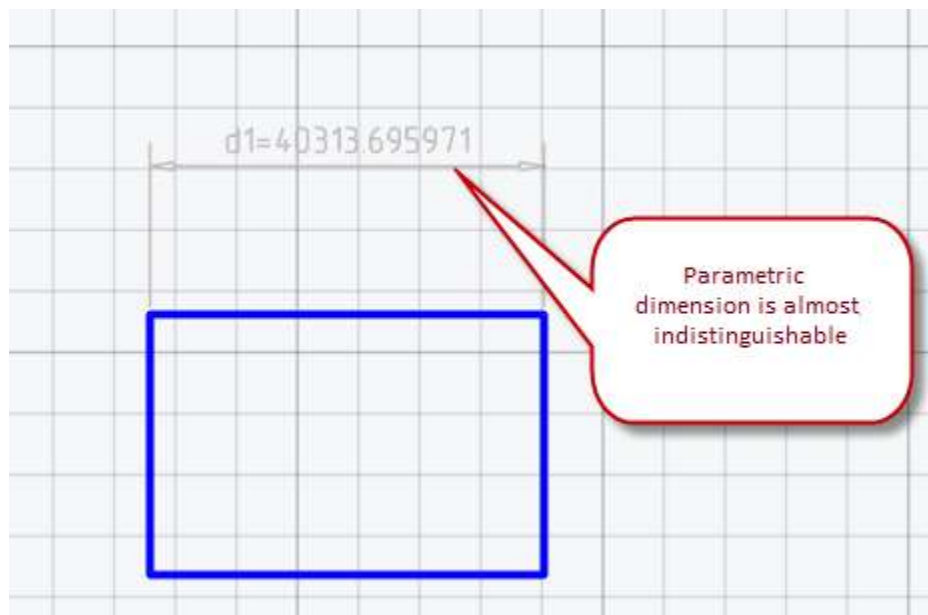

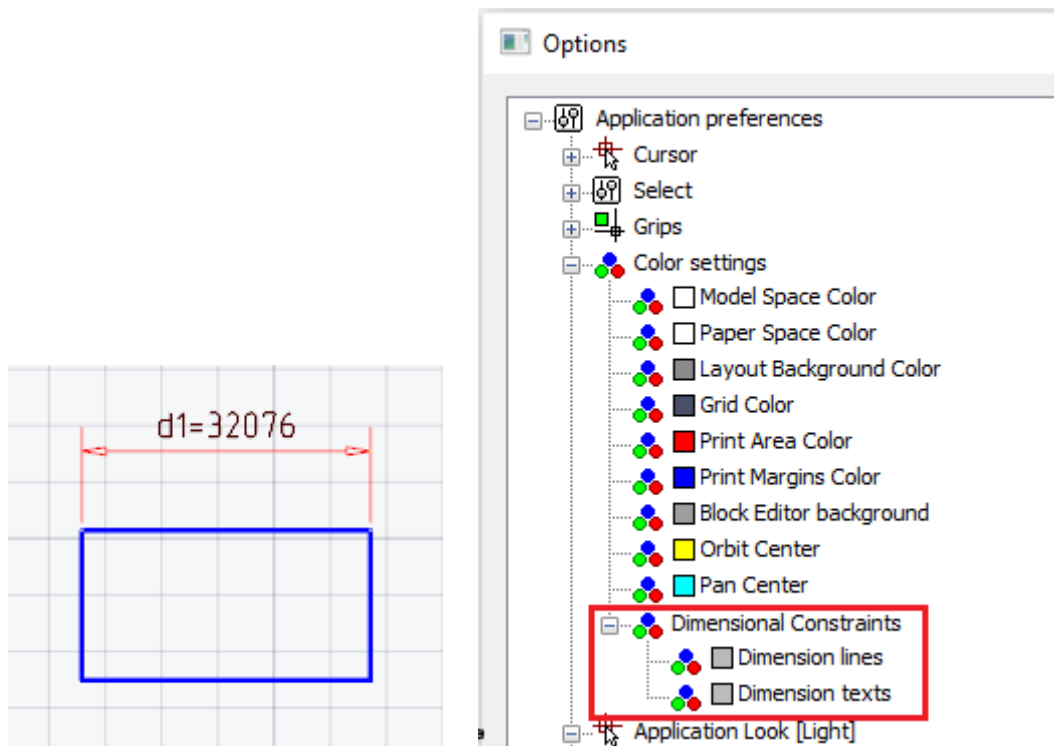

In the following cases, the visual style is automatically set to **Top SW Iso**:

- When entering sketch editing mode (PSADD), if there are no 3D constructions in the document, and the view is oriented along one of the WCS axes;
- When entering the 3D block editing mode (3DBEDIT).

Also, in the 3D block editing mode (3DBEDIT), the display style is automatically set to **Gouraud shaded with edges**.

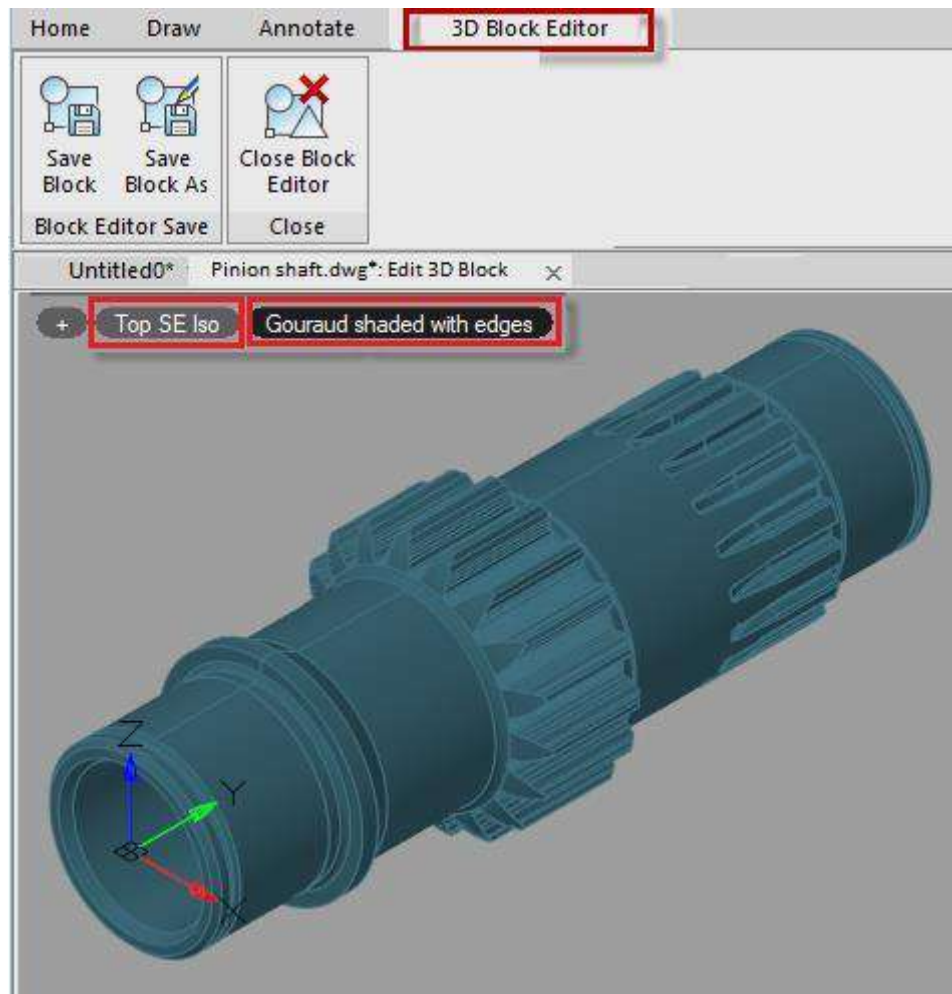

The program behavior has been fixed, when in the 3D block editing mode, after launching any 3D command or switching the 3D modeling, the ribbon each time switched to the **3D Block Editor** tab.

The work of angular 3D constraint (3DANGLE) at large angles has been fixed. For this, when applying a 3D angular constraint, the user is given the opportunity to set the rotation axis so that it can be unambiguously determined how to measure angles of more than 180 degrees.

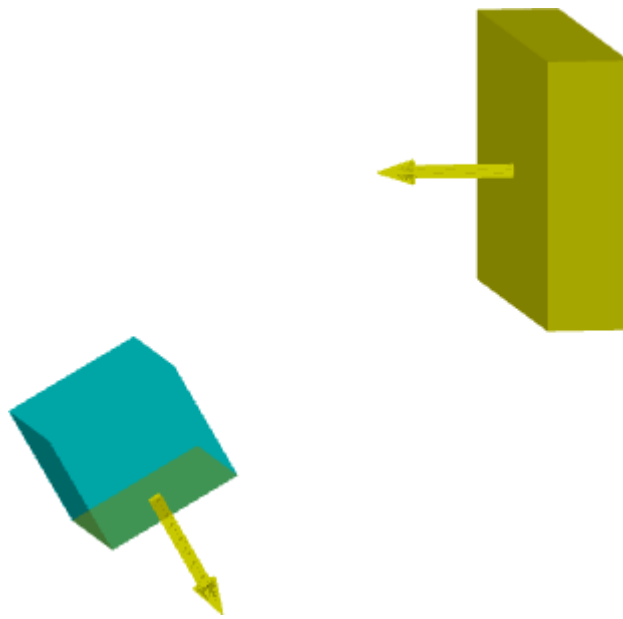

```
3dangle - Angle 3D Constraint  
Select first geometry or [Autodetect/Plane/Line ]<Autodetect>:  
Select second geometry or [Autodetect/Plane/Line ]<Autodetect>:  
Enter angle or [Rotation axis]:
```

## Corrections

The bug due to which a crash occurred when trying to extrude a contour containing an ellipse or spline has been fixed.

An incorrect behavior of the **Presspull** (PRESSPULL) command when moving multiple faces has been fixed.

The bug due to which the angular constraint did not save the direction and could suddenly start counting in the other direction has been fixed.

The bug where it was not possible to create a 2D constraint to align a polyline vertex with a point has been fixed.

The bug due to which changes to hide 3D objects using isolation in files with 3D models were not saved has been fixed.

In the 3D Module command **Convert to Solid** (CONVTOSOLID), the error of converting a mesh to a solid, which occurs when the mesh was located at a large distance from the coordinate origin, has been fixed. In this case, the level of detail during the conversion turned out to be too low.

# CONSTRUCTION MODULE

\* The most up-to-date information of the new features of Construction Module is available [online](#).

## BCF

Now there is the possibility to comment on projects. The BCF project allows you to create and store a set of notes inside a \*.dwg file to organize joint work on an object.

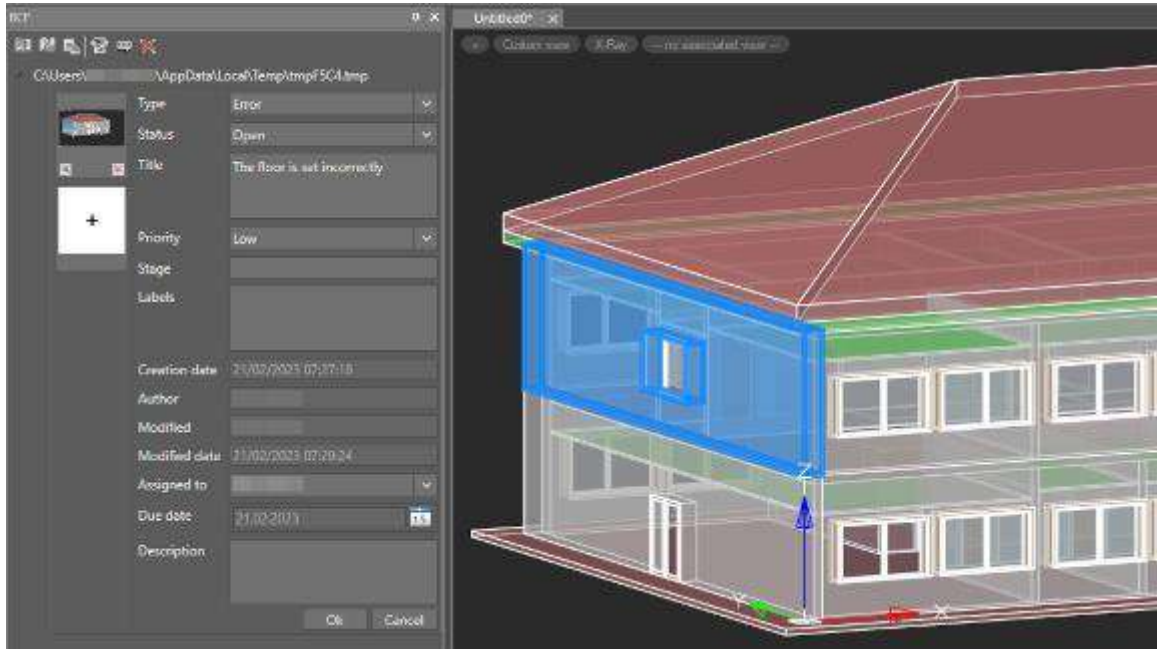

## Library

The Density has been added to the Library of Materials.

## Corrections

The bug due to which the nanoCAD crashed when importing an object into the database has been fixed.

The import of IFC object colors has been fixed: door opening direction and number of objects in all groups.

The errors in building the contour of the premises with a magnet have been fixed.

An incorrect display of the **Room** dialog has been fixed.

In the explication of premises, it became possible to set the separator.

The bug where, after double-clicking on a dwg file associated with the Construction / Mechanica module, a clean nanoCAD document was opened without a loaded module and this file, has been fixed.



# MECHANICA MODULE

You can find more complete description of the new features of Mechanica Module [online](#)

## Assembly Units

The Mechanica module has been supplemented with additional features for 3D design of assembly units. The new tools are designed to meet the needs of automating the creation of drawings and specifications.

The file type can be changed depending on the purpose:

- not specified;
- part;
- assembly.

## Changing 3D Type of an Assembly Unit

The specified file type has the appropriate properties and is passed to the specification.

The file with the assigned type **Not selected** is a regular \*.dwg file, in which you can draw up two-dimensional drawings and specifications.

For files of the **Part** and **Assembly** types, the following properties have been added, which are necessary when creating specifications for 3D models:

- section;
- name;
- designation;
- note.

In the properties of parts and assemblies files (**Stamps Data** section), fields for the main, inventory and reference inscriptions of drawings and specifications have been created. When creating a drawing or specification, they are associated with the corresponding format fields.

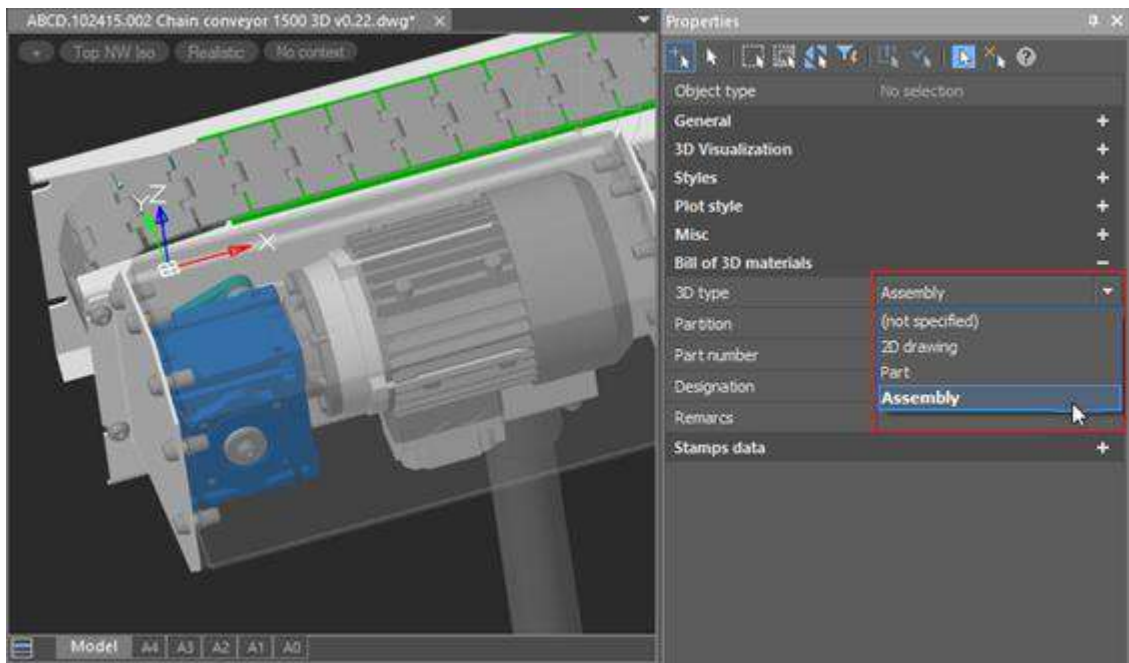

## Document Properties Window

Assembly design is performed using external references, when assembly unit files are compiled from part files using such references. In turn, assembly units consisting of several parts can be part of larger assembly units. Thus, you can get the desired level of nesting of assembly units, form the design composition of an item in the history of building the assembly model.

When using external references in 3D model files of parts and assembly units, the corresponding drawings can be formed in the paper space of external files without overloading the model space and maintaining the associativity of the 3D model and drawing.

In the properties of parts and assembly units, you can specify such data as section, name, designation and note, as well as data for filling drawing stamps. If you use a part or assembly as a block multiple times, copy the block or use the Insert Block command. By assembling from blocks, you can generate a specification and prepare an assembly drawing.

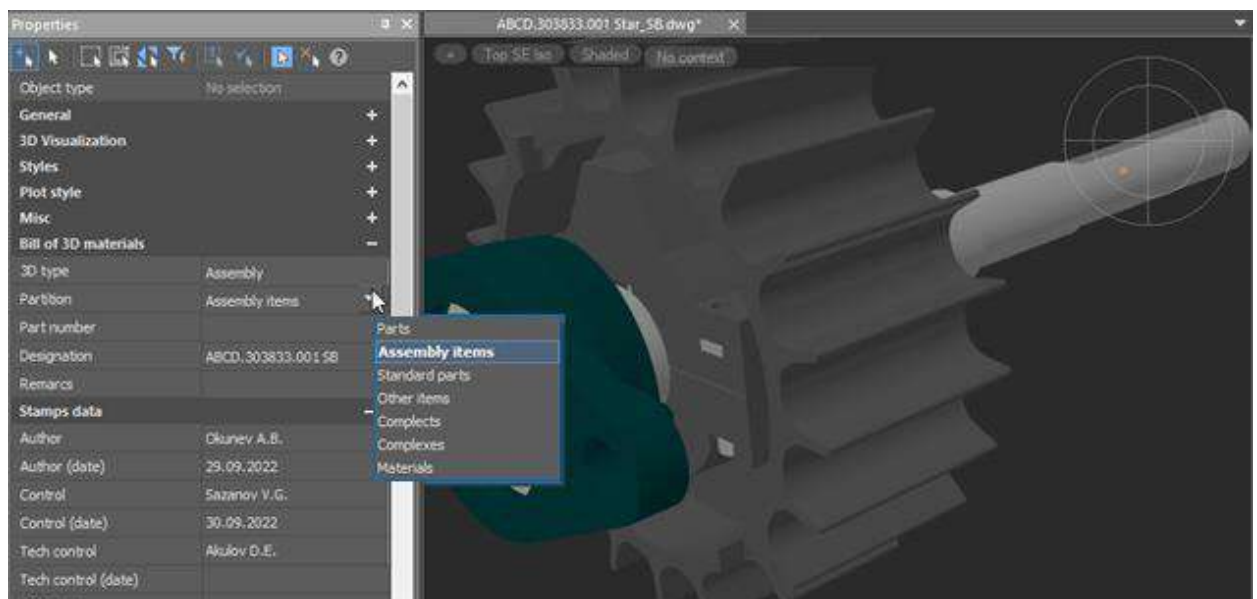

## Assembly Unit Properties Window

Blocks with parts and assembly units can be copied from one file to another, while all their properties are preserved.

When forming specification from a 3D model, data are collected from the assembly, such as the names and designations of parts and assembly units, sections of the specification in which these assemblies should fall, as well as notes for the specification.

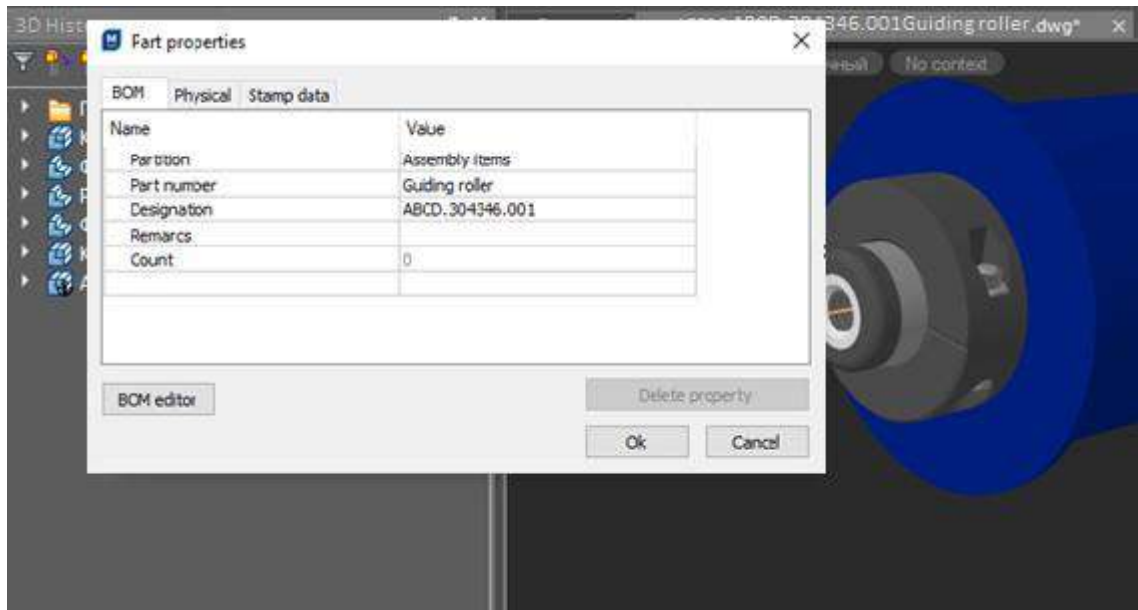

## Specification by 3D Model

Blocks with parts and assembly units can be copied from one file to another, at that all their properties are preserved.

When forming specification from a 3D model, data are collected from the assembly, such as the names and designations of parts and assembly units, sections of the specification in which these assemblies should fall, as well as notes for the specification.

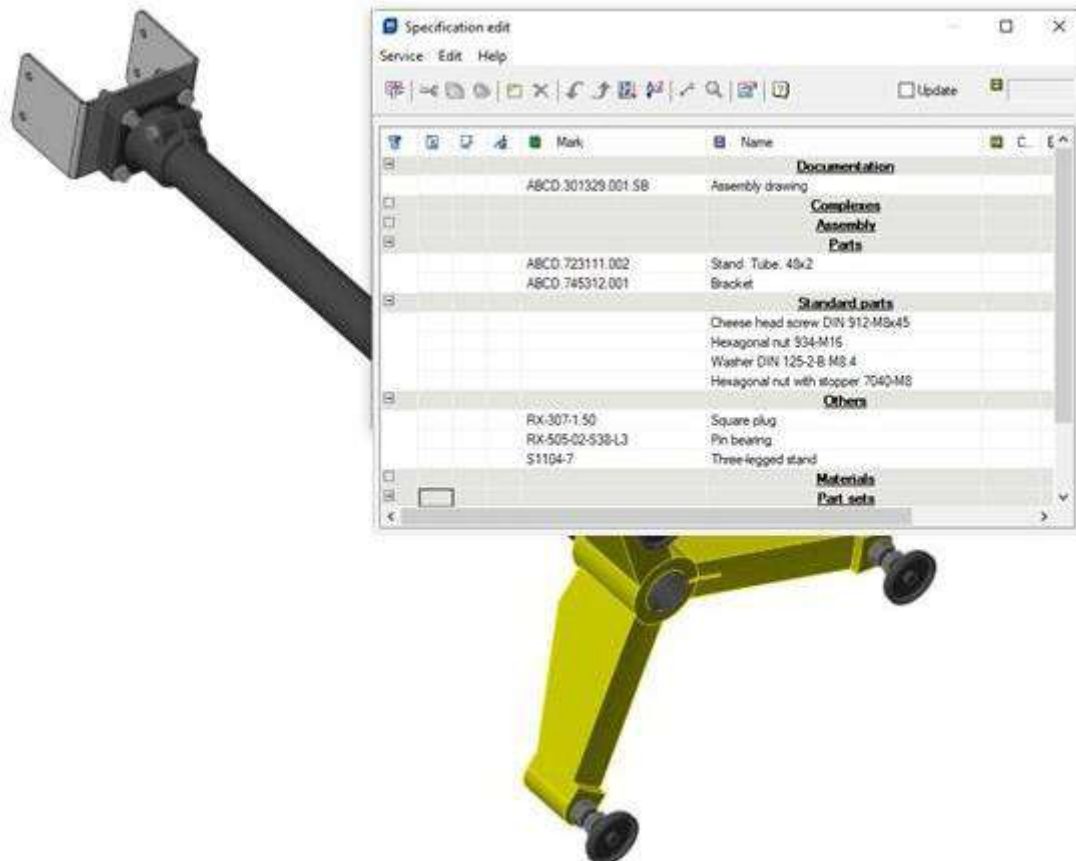

In views of 3D model of an assembly, you can place numbered leaders of specification positions. Specification leaders position numbers are synchronized with the specification editor, and specification elements can be renumbered.

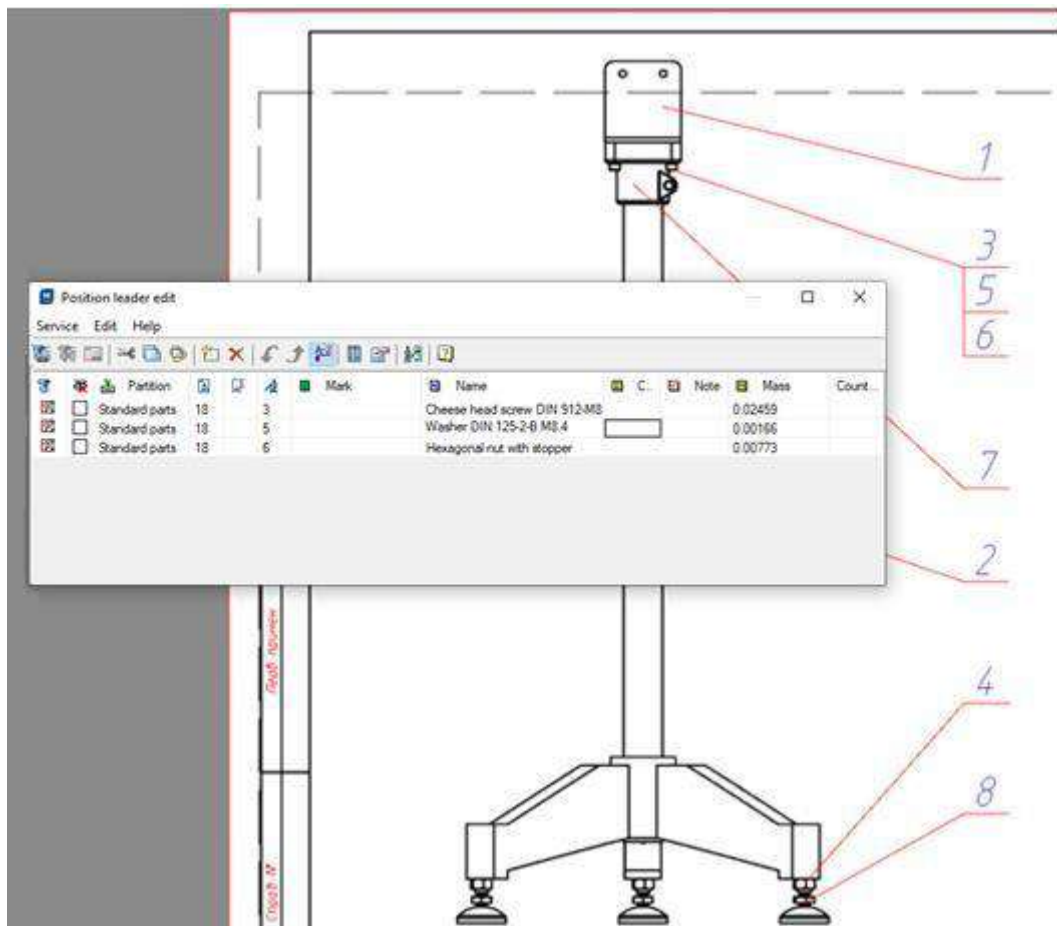

## Specification Positions

3D parts can be assigned with materials from the element database that have a density value, as well as universal custom materials, for which you can specify any desired density. Based on the material's density and the part's geometric volume, the part weight is automatically calculated. If the parts are assembled into an assembly unit, the weight of such an assembly unit will consist of the weights of the parts included in it. And by the weight of the included parts and assembly units, you can determine the total weight of the main assembly.

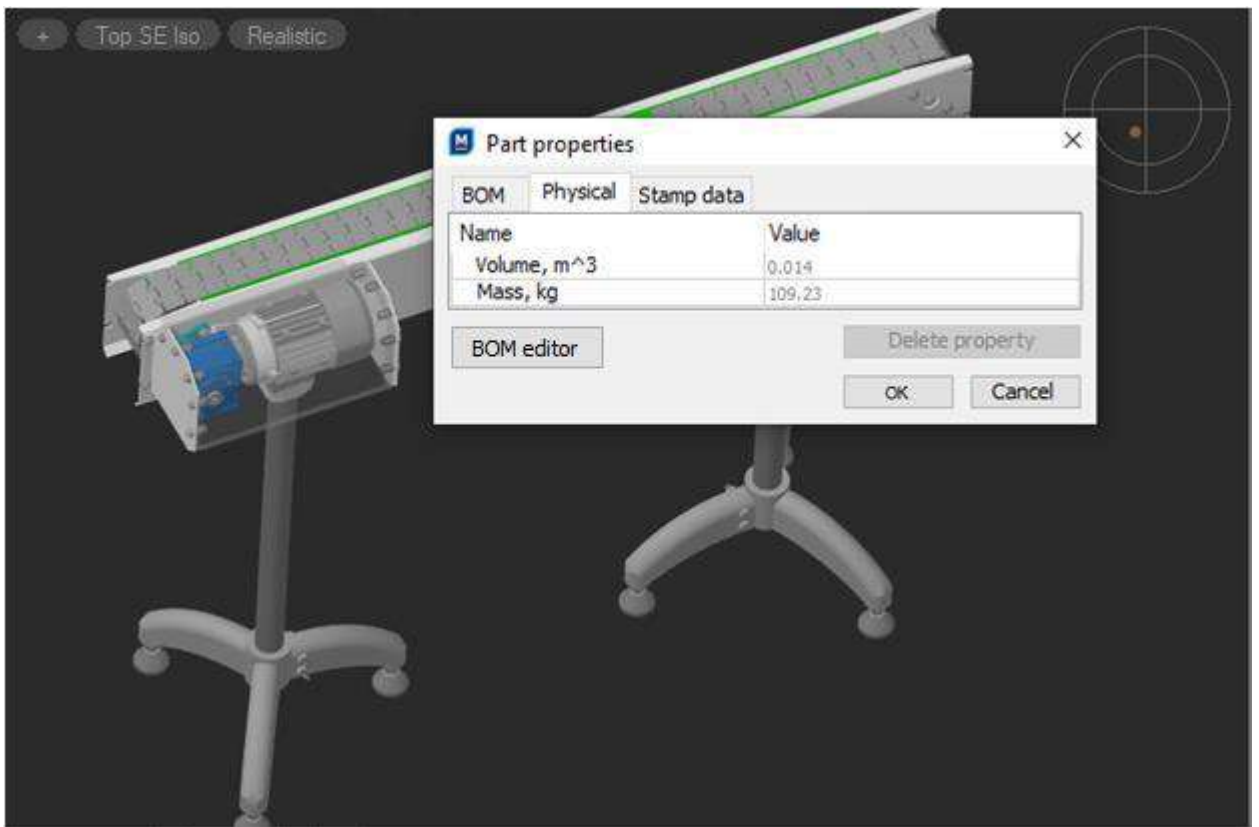

## Stamping

When creating stamping, you can now select multiple closed contours (sketch areas) at once.

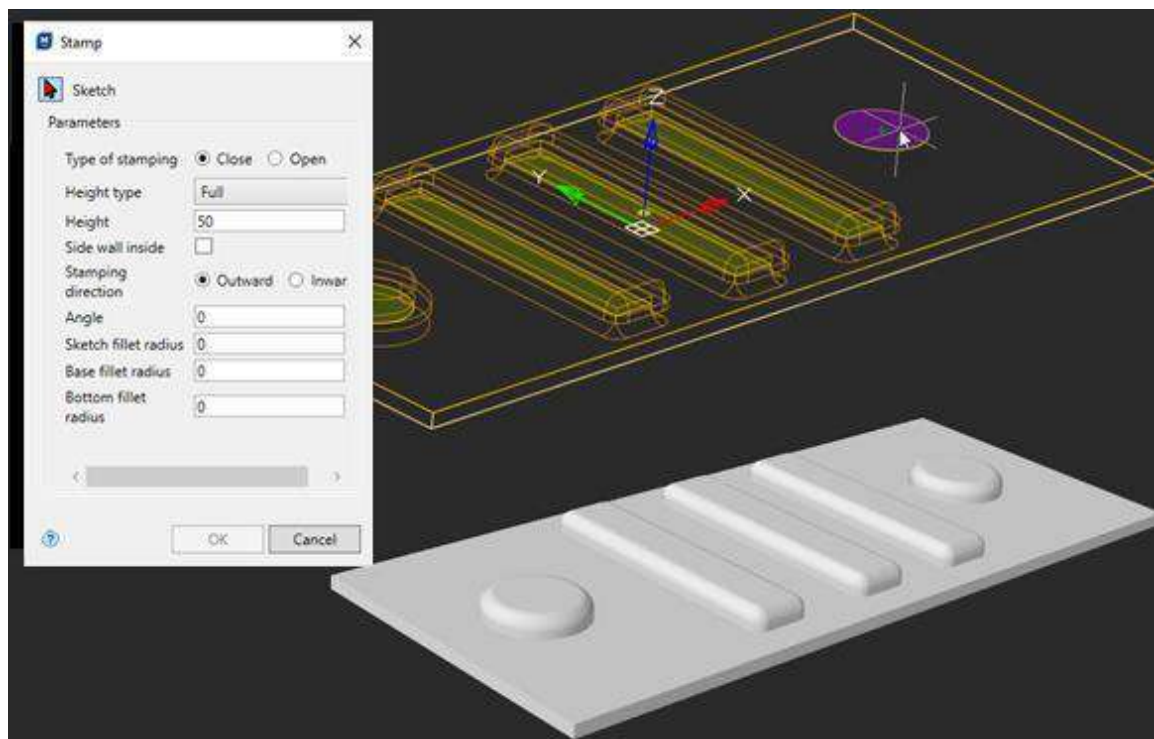

## Flanging

The Flange sheet modeling command has appeared, which allows you to create a bend in a sheet metal part along a flat edge of arbitrary shape or a chain of edges that meet tangentially.

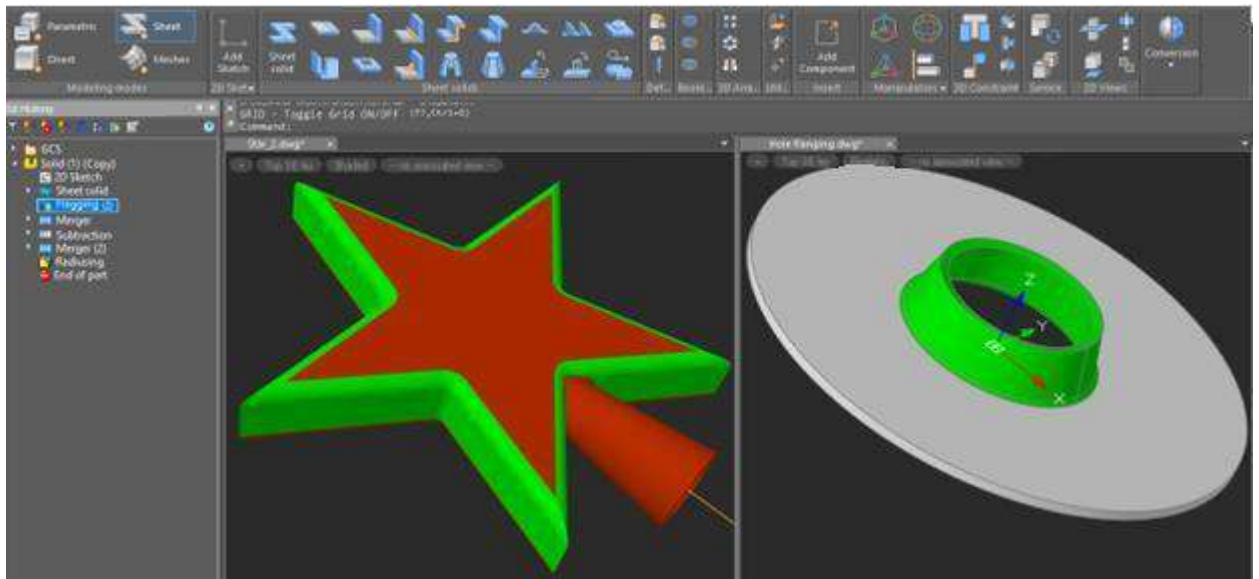

In the Mechanics module, grid display in model space is now disabled by default.